

N-Channel Enhancement Mode Field Effect Transistor

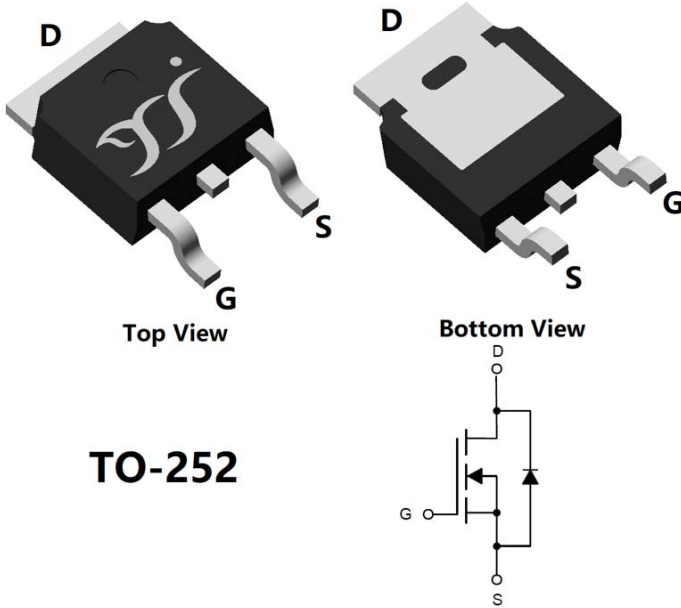

TO-252

Product Summary

- V_{DS} 40V
- I_D 140A
- $R_{DS(on)}$ (at $V_{GS}=10V$) <math><2.8m\Omega</math>
- 100% EAS Tested
- 100% ∇V_{DS} Tested

General Description

- Low $R_{DS(on)}$ & FOM
- Extremely low switching loss
- Excellent stability and uniformity
- Fast switching and soft recovery
- Moisture Sensitivity Level 1
- Part no. with suffix "Q" means AEC-Q101 qualified

Applications

- Power switching application
- Hard switched and high frequency circuits
- Uninterruptible power supply
- DC-DC convertor
- 12V Automotive systems

■ Absolute Maximum Ratings ($T_A=25^\circ C$ unless otherwise noted)

| Parameter | | Symbol | Limit | Unit |
|--|-------------------|----------------|----------|------------|
| Drain-source Voltage | | V_{DS} | 40 | V |
| Gate-source Voltage | | V_{GS} | ± 20 | V |
| Drain Current | $T_C=25^\circ C$ | I_D | 140 | A |
| | $T_C=100^\circ C$ | | 99 | |
| | $T_A=25^\circ C$ | | 25 | |
| | $T_A=100^\circ C$ | | 17 | |
| Pulsed Drain Current ^A | | I_{DM} | 400 | A |
| Avalanche energy ^B | | EAS | 315 | mJ |
| Total Power Dissipation ^C | $T_C=25^\circ C$ | P_D | 100 | W |
| | $T_C=100^\circ C$ | | 50 | |
| | $T_A=25^\circ C$ | | 3 | |
| | $T_A=100^\circ C$ | | 1.5 | |
| Junction and Storage Temperature Range | | T_J, T_{STG} | -55~+175 | $^\circ C$ |



YJD2D8G04HHQ

■ Thermal resistance

| Parameter | | Symbol | Typ | Max | Units |
|---|--------------|-----------------|-----|-----|-------|
| Thermal Resistance Junction-to-Ambient ^D | Steady-State | $R_{\theta JA}$ | 40 | 50 | °C/W |
| Thermal Resistance Junction-to-Case | Steady-State | $R_{\theta JC}$ | 1.2 | 1.5 | |

■ Ordering Information (Example)

| PREFERRED P/N | PACKING CODE | Marking | MINIMUM PACKAGE(pcs) | INNER BOX QUANTITY(pcs) | OUTER CARTON QUANTITY(pcs) | DELIVERY MODE |
|---------------|--------------|------------|----------------------|-------------------------|----------------------------|---------------|
| YJD2D8G04HHQ | F1 | YJD2D8G04H | 2500 | / | 25000 | 13"Reel |

- A. Repetitive rating; pulse width limited by max. junction temperature.
- B. $T_J=25^{\circ}\text{C}$, $V_{DD}=30\text{V}$, $V_G=10\text{V}$, $R_G=25\Omega$, $L=0.5\text{mH}$, $I_{AS}=35.5\text{A}$.
- C. P_q is based on max. junction temperature, using junction-case thermal resistance.
- D. The value of $R_{\theta JA}$ is measured with the device mounted on the minimum recommend pad size, in the still air environment with $T_A=25^{\circ}\text{C}$. The maximum allowed junction temperature of 175°C . The value in any given application depends on the user's specific board design.



YJD2D8G04HHQ

■ Electrical Characteristics (T_J=25°C unless otherwise noted)

| Parameter | Symbol | Conditions | Min | Typ | Max | Units |
|-----------------------------------|---------------------|---|-----|------|------|-------|
| Static Parameter | | | | | | |
| Drain-Source Breakdown Voltage | BV _{DSS} | V _{GS} = 0V, I _D =250μA | 40 | | | V |
| Zero Gate Voltage Drain Current | I _{DSS} | V _{DS} =40V, V _{GS} =0V | | | 1 | μA |
| Gate-Body Leakage Current | I _{GSS} | V _{GS} = ±20V, V _{DS} =0V | | | ±100 | nA |
| Gate Threshold Voltage | V _{GS(th)} | V _{DS} = V _{GS} , I _D =250μA | 2 | 3 | 4 | V |
| Static Drain-Source On-Resistance | R _{DS(ON)} | V _{GS} =10V, I _D =20A | | 2.2 | 2.8 | mΩ |
| Diode Forward Voltage | V _{SD} | I _S =20A, V _{GS} =0V | | 0.8 | 1.2 | V |
| Gate resistance | R _G | f=1MHz | | 2 | | Ω |
| Dynamic Parameters | | | | | | |
| Input Capacitance | C _{iss} | V _{DS} =25V, V _{GS} =0V, f=1MHz | - | 3344 | - | pF |
| Output Capacitance | C _{oss} | | - | 977 | - | |
| Reverse Transfer Capacitance | C _{rss} | | - | 39 | - | |
| Switching Parameters | | | | | | |
| Total Gate Charge | Q _g | V _{GS} =10V, V _{DS} =20V, I _D =45A | - | 42.2 | - | nC |
| Gate-Source Charge | Q _{gs} | | - | 15.4 | - | |
| Gate-Drain Charge | Q _{gd} | | - | 9.4 | - | |
| Reverse Recovery Charge | Q _{rr} | I _F =30A, di/dt=150A/us | - | 40 | - | nC |
| Reverse Recovery Time | t _{rr} | | - | 38 | - | ns |
| Turn-on Delay Time | t _{D(on)} | V _{GS} =10V, V _{DD} =20V, I _D =45A R _{GEN} =2.2Ω | - | 20.3 | - | ns |
| Turn-on Rise Time | t _r | | - | 209 | - | |
| Turn-off Delay Time | t _{D(off)} | | - | 25 | - | |
| Turn-off fall Time | t _f | | - | 12.3 | - | |



YJD2D8G04HHQ

Typical Electrical and Thermal Characteristics Diagrams

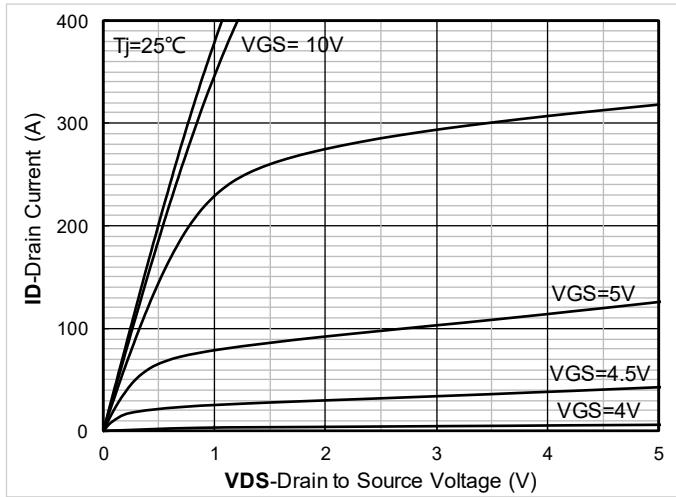

Figure 1. Output Characteristics

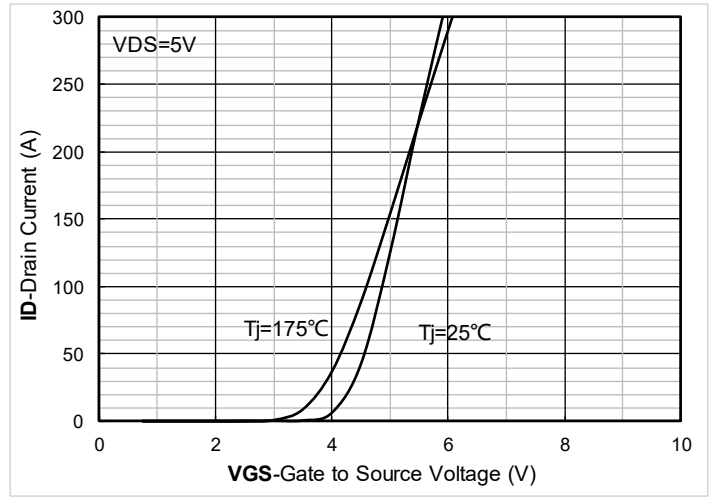

Figure 2. Transfer Characteristics

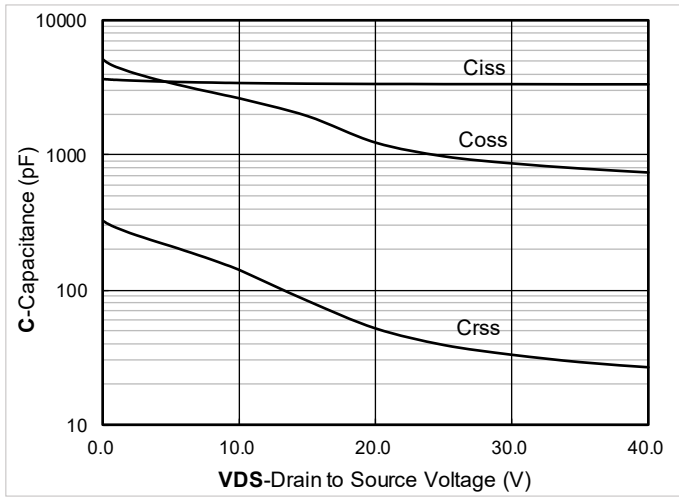

Figure 3. Capacitance Characteristics

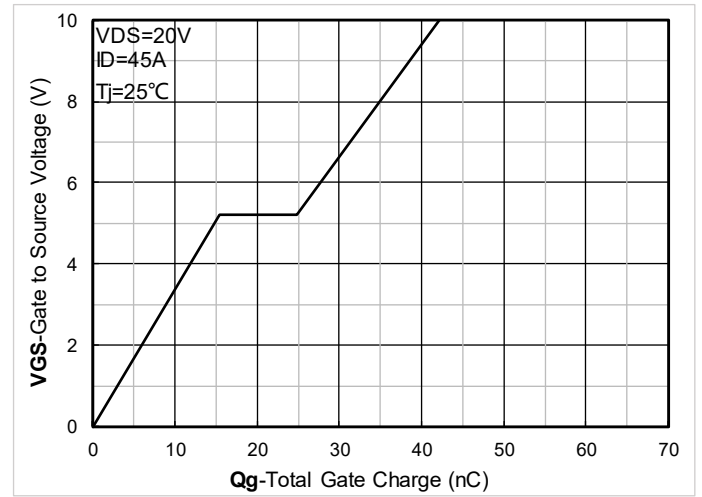

Figure 4. Gate Charge

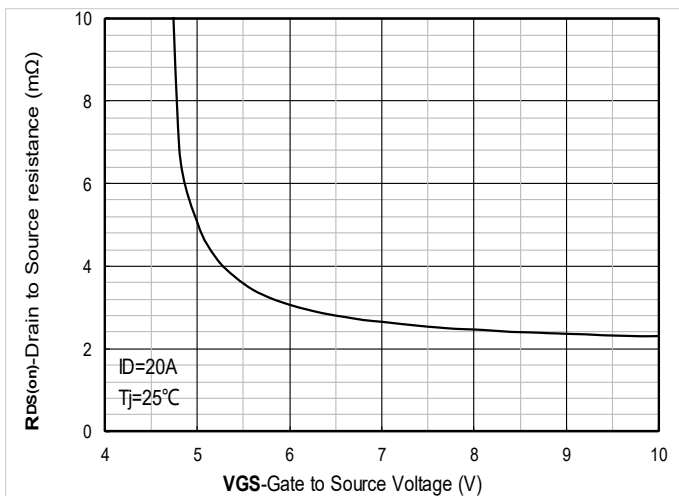

Figure 5. On-Resistance vs Gate to Source Voltage

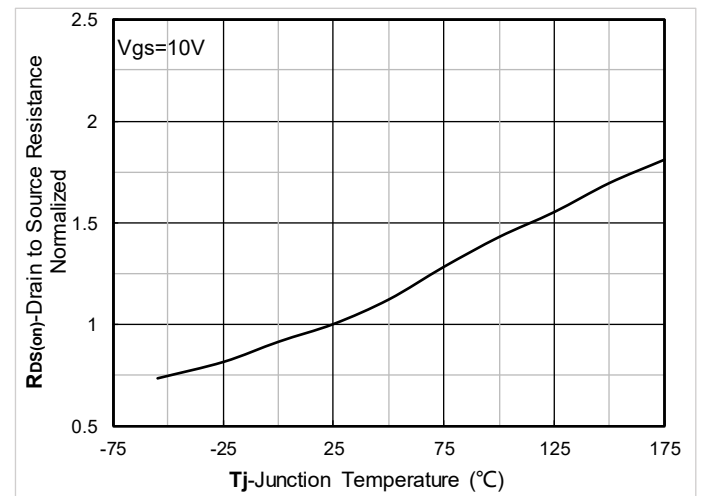

Figure 6. Normalized On-Resistance



YJD2D8G04HHQ

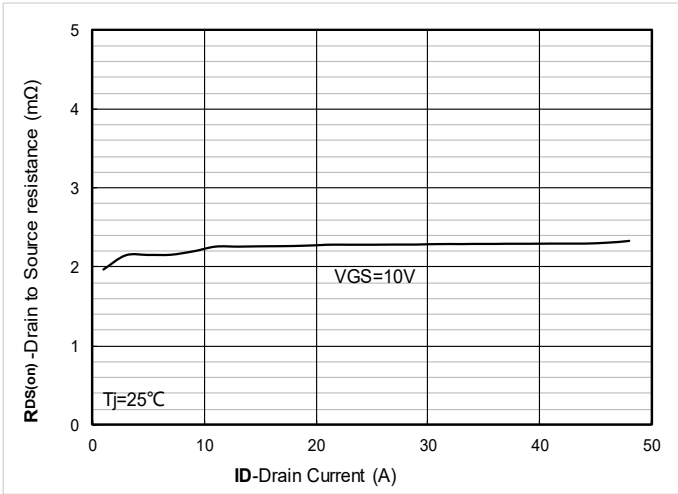

Figure 7. RDS(on) VS Drain Current

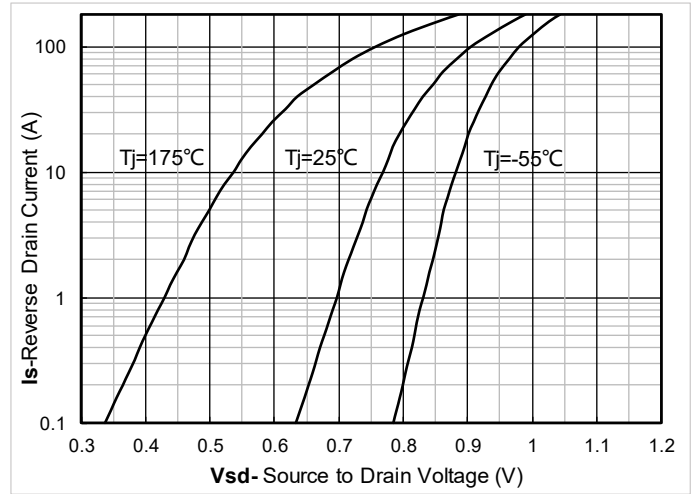

Figure 8. Forward characteristics of reverse diode

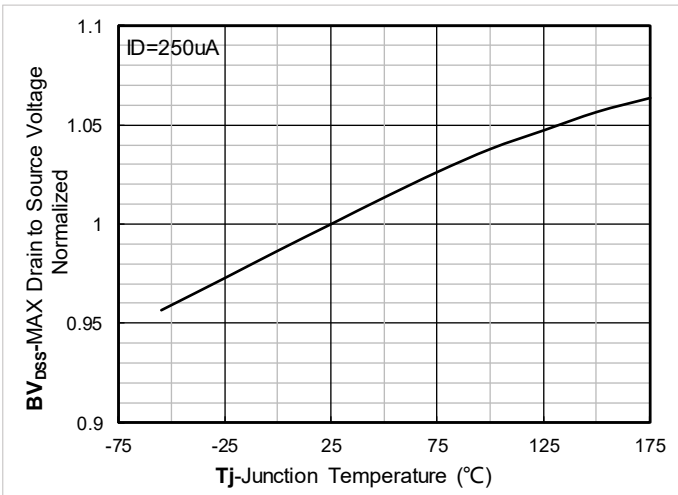

Figure 9. Normalized breakdown voltage

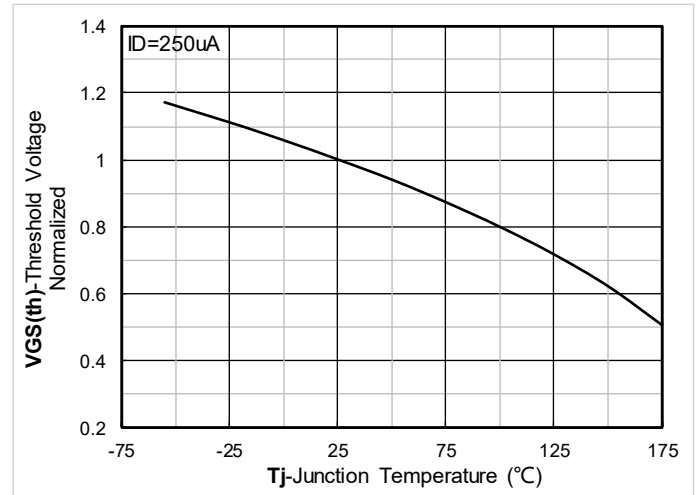

Figure 10. Normalized Threshold voltage

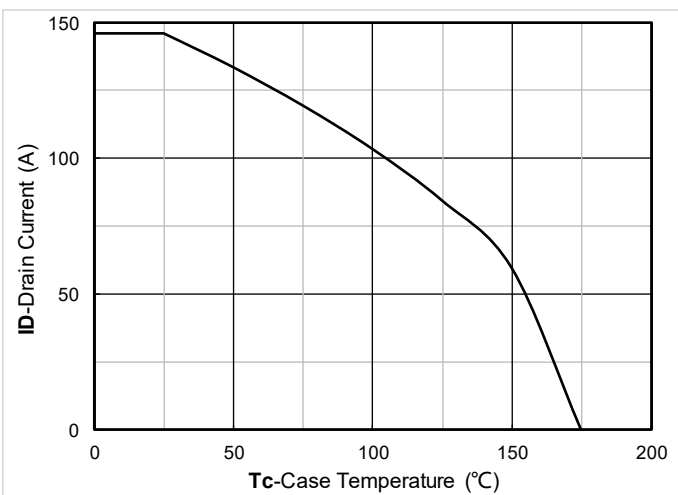

Figure 11. Current dissipation

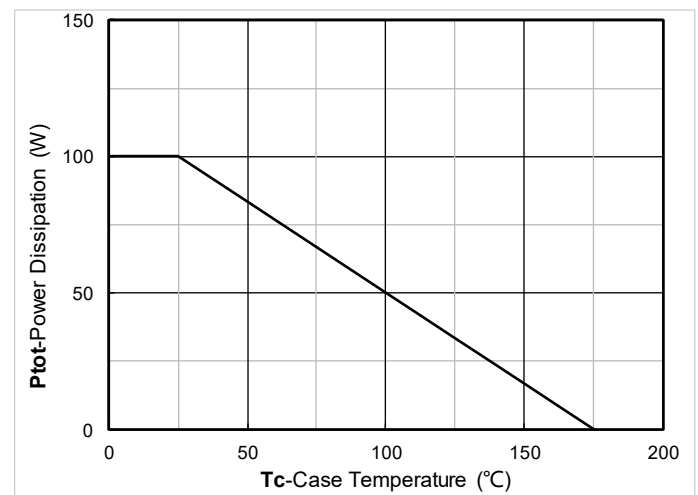

Figure 12. Power dissipation



YJD2D8G04HHQ

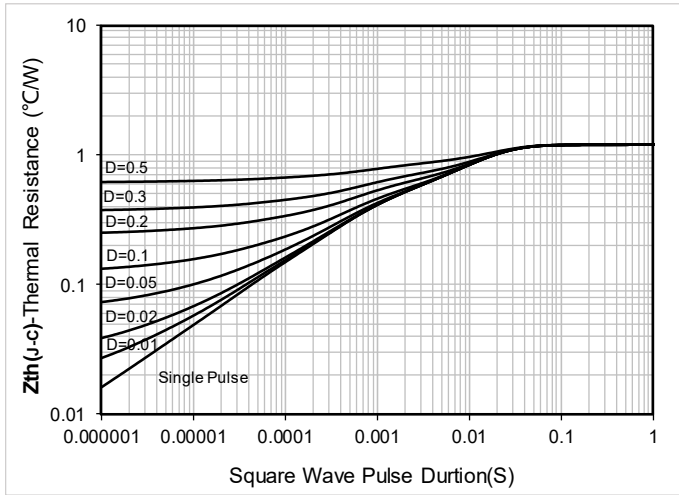

Figure 13. Maximum Transient Thermal Impedance

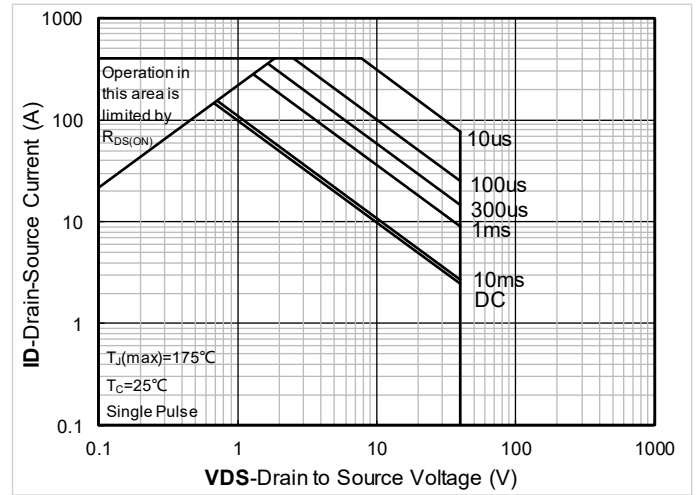
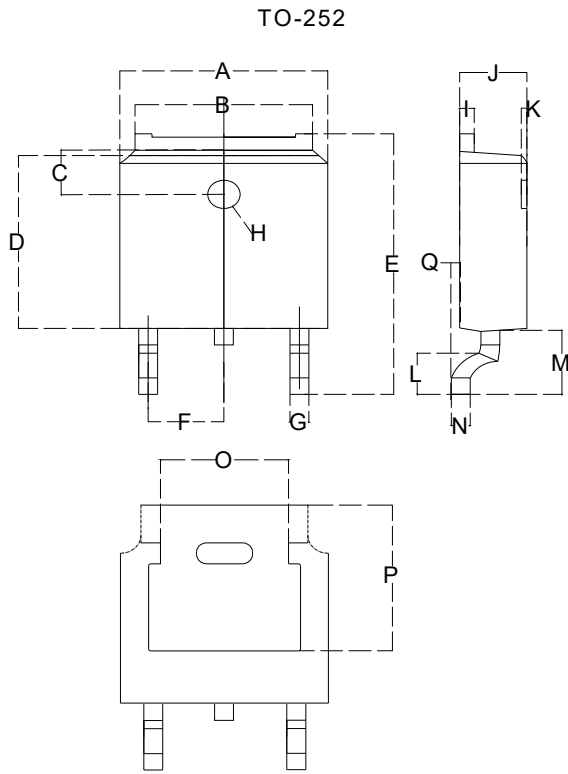

Figure 14. Safe Operation Area



YJD2D8G04HHQ

■ TO-252 Package information



Dimensions in millimeters

| TO-252 | | |
|--------|--------|--------|
| Dim | Min | Max |
| A | 6.500 | 6.700 |
| B | 5.100 | 5.460 |
| C | 1.400 | 1.800 |
| D | 6.000 | 6.200 |
| E | 10.000 | 10.400 |
| F | 2.166 | 2.366 |
| G | 0.660 | 0.860 |
| H | Φ1.050 | Φ1.350 |
| I | 0.460 | 0.580 |
| J | 2.200 | 2.400 |
| K | 0 | 0.300 |
| L | 0.890 | 2.290 |
| M | 2.730 | 3.080 |
| N | 0.430 | 0.580 |
| O | 4.20 | 4.95 |
| P | 5.15 | 5.45 |
| Q | 0 | 0.2 |

■ Suggested Pad Layout

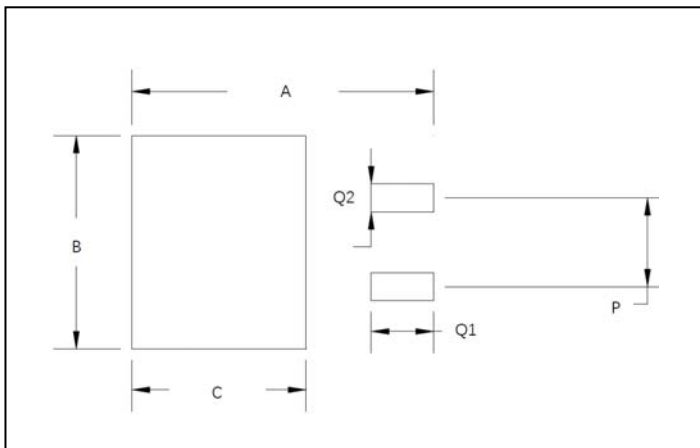

| Dim | Millimeters |
|-----|-------------|
| A | 11.4 |
| B | 6.74 |
| C | 6.23 |
| P | 4.56 |
| Q1 | 2.28 |
| Q2 | 1.52 |



Disclaimer

The information presented in this document is for reference only. Yangzhou Yangjie Electronic Technology Co., Ltd. reserves the right to make changes without notice for the specification of the products displayed herein to improve reliability, function or design or otherwise.

The product listed herein is designed to be used with automotive electronics, are not designed for use in medical, life-saving, lifesustaining, or military, Yangjie or anyone on its behalf, assumes no responsibility or liability for any damages resulting from such improper use of sale.

This publication supersedes & replaces all information previously supplied. For additional information, please visit our website <http://www.21yangjie.com>, or consult your nearest Yangjie's sales office for further assistance.