

Low VF Bridge Rectifiers

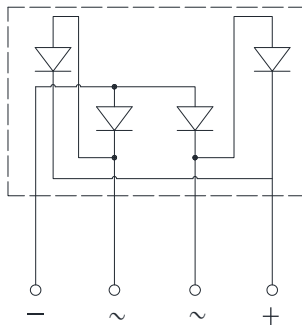
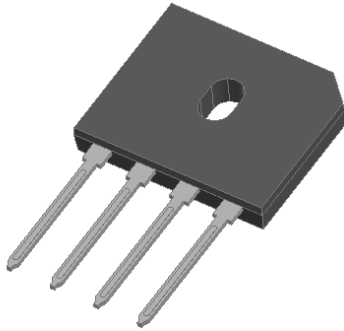

Features

- UL recognition, file #E230084
- based on silicon planar process
- Ideal for printed circuit boards
- High surge current capability
- Low VF
- Solder dip 275 °C max. 7 s, per JESD 22-B106

Typical Applications

General purpose use in AC/DC bridge full wave Rectification for monitor, TV, printer, power supply, switching mode power supply, adapter, audio equipment, and home appliances applications.

Mechanical Data

- **Package:** GBU
Molding compound meets UL 94 V-0 flammability rating, RoHS-compliant
- **Terminals:** Tin plated leads, solderable per J-STD-002 and JESD22-B102
- **Polarity:** As marked on body

■Maximum Ratings (T_a=25°C Unless otherwise specified)

PARAMETER	SYMBOL	UNIT	GBUU1506	
Device marking code			GBUU1506	
Maximum Repetitive Peak Reverse Voltage	VRRM	V	600	
Maximum RMS Voltage	VRMS	V	420	
Maximum DC blocking Voltage	VDC	V	600	
Average rectified output current @60Hz sine wave, R-load	With heatsink T _c =110°C	IO	A	15.0
	Without heatsink T _a =25°C			3.5
Forward Surge Current (Non-repetitive) @60Hz Half-sine wave, 1 cycle, T _j =25°C	IFSM	A	220	
Forward Surge Current (Non-repetitive) @1ms, square wave, 1 cycle, T _j =25°C			440	
Current squared time @1ms≤t≤8.3ms T _j =25°C, Rating of per diode	I ² t	A ² S	200.9	
Storage temperature	T _{stg}	°C	-55 ~ +150	
Junction temperature	T _j	°C	-55 ~ +150	
Dielectric strength @ terminals to case, AC 1 minute	V _{dis}	KV	2.5	
Mounting torque @recommend torque: 5kg·cm	T _{or}	kg·cm	8.0	



GBUU1506

■ Electrical Characteristics (T_a=25°C Unless otherwise specified)

PARAMETER	SYMBOL	UNIT	TEST CONDITIONS	Min	Typ	Max
Instantaneous forward voltage drop per diode	V _F	V	I _{FM} =7.5A	0.80	0.88	0.92
DC reverse current at rated DC blocking voltage per diode	I _R	μA	T _j =25°C	-	0.08	5
			T _j =125°C	-	2.5	50
Junction capacitance	C _j	pF	Measured at 1MHz and Applied Reverse Voltage of 4.0 V.D.C	64	128	250

■ Thermal Characteristics (T_a=25°C Unless otherwise specified)

PARAMETER		SYMBOL	UNIT	GBUU1506
Thermal Resistance	Between junction and ambient, Without heatsink	R _{θJ-A}	°C/W	25.0
	Between junction and case, With heatsink	R _{θJ-C}		1.4
	Between junction and Lead With heatsink	R _{θJ-L}		5

Note: Device mounted on 75mm x 45mm x 5.5mm Aluminum Plate Heatsink.

■ Ordering Information (Example)

PREFERRED P/N	PACKING CODE	UNIT WEIGHT(g)	MINIMUM PACKAGE(pcs)	INNER BOX QUANTITY(pcs)	OUTER CARTON QUANTITY(pcs)	DELIVERY MODE
GBUU1506	B1	Approximate 3.95	20	1000	2000	TUBE

■ Characteristics (Typical)

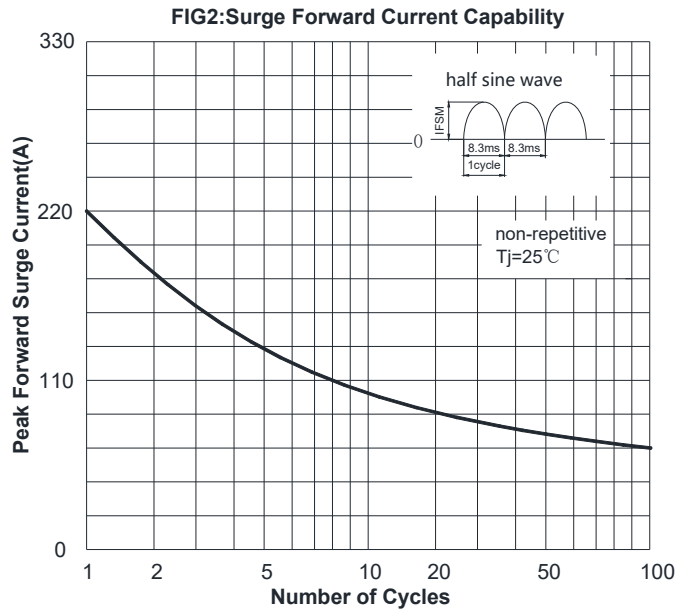
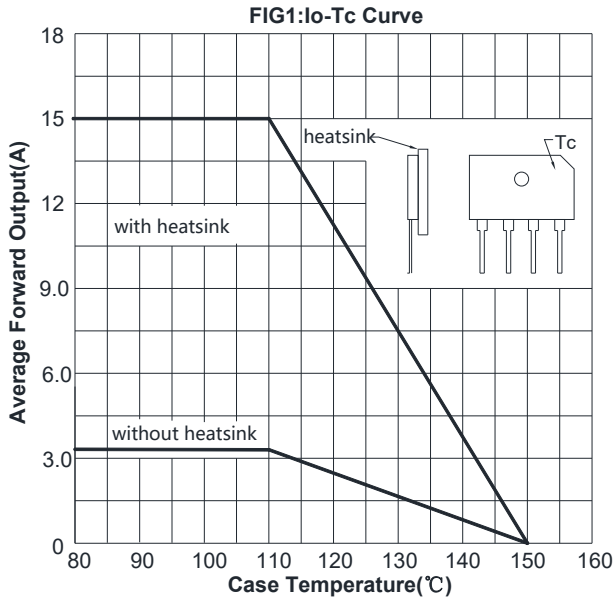

FIG3: Typical Forward Voltage

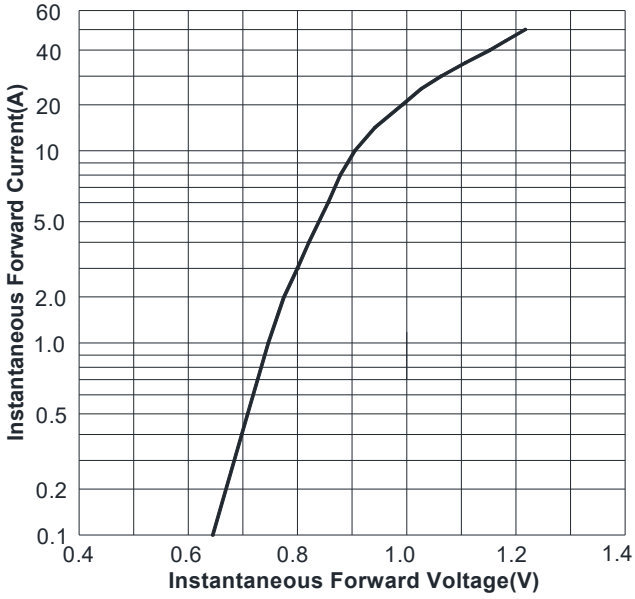
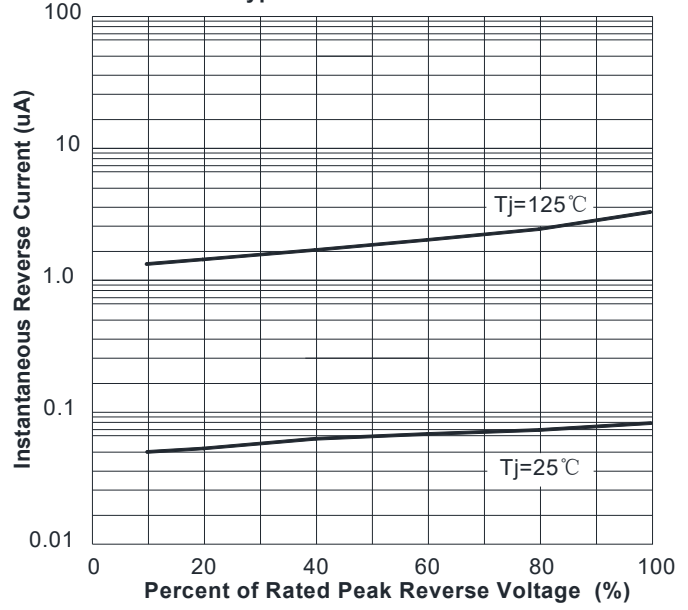
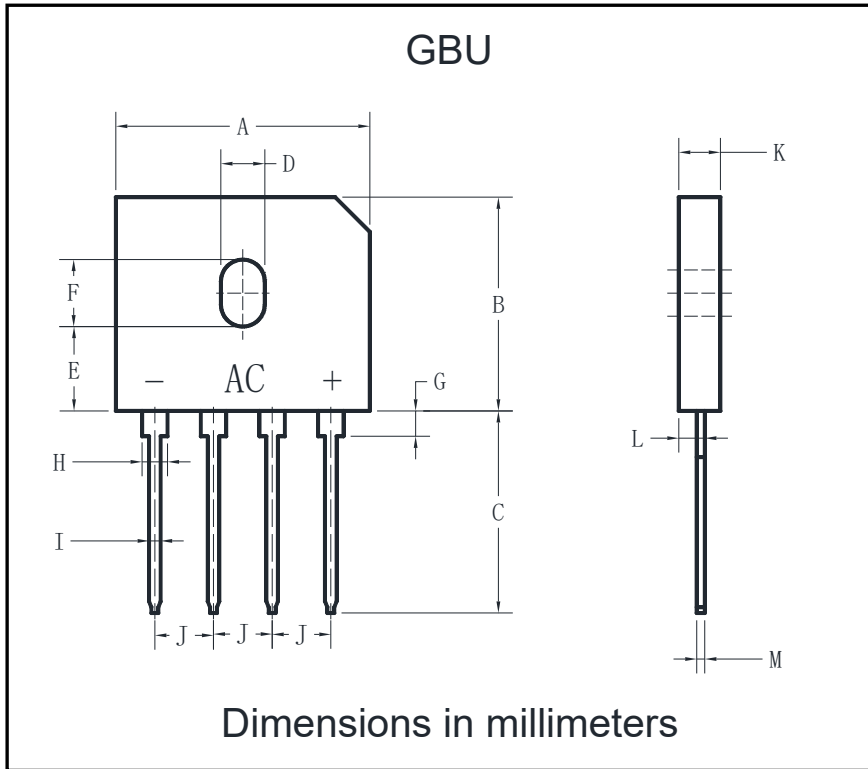

FIG4: Typical Reverse Characteristics



Outline Dimensions



GBU		
Dim	Min	Max
A	21.80	22.30
B	18.30	18.80
C	17.50	18.00
D	3.30	3.90
E	7.10	7.50
F	5.50	5.90
G	1.91	2.54
H	2.06	2.54
I	1.02	1.27
J	4.83	5.33
K	3.30	3.56
L	2.40	2.66
M	0.46	0.56



Disclaimer

The information presented in this document is for reference only. Yangzhou Yangjie Electronic Technology Co., Ltd. reserves the right to make changes without notice for the specification of the products displayed herein to improve reliability, function or design or otherwise.

The product listed herein is designed to be used with ordinary electronic equipment or devices, and not designed to be used with equipment or devices which require high level of reliability and the malfunction of which would directly endanger human life (such as medical instruments, transportation equipment, aerospace machinery, nuclear-reactor controllers, fuel controllers and other safety devices), Yangjie or anyone on its behalf, assumes no responsibility or liability for any damages resulting from such improper use of sale.

This publication supersedes & replaces all information previously supplied. For additional information, please visit our website [http:// www.21yangjie.com](http://www.21yangjie.com) , or consult your nearest Yangjie's sales office for further assistance.