



焊盘尺寸图

Weld pad size drawing

成为世界信赖的功率半导体伙伴

Let the world trust China semiconductor

01

整流器件产品焊盘尺寸图

Rectifiers weld pad size drawing

02

保护器件产品焊盘尺寸图

protection devices weld pad size drawing

03

小信号产品焊盘尺寸图

small signal weld pad size drawing

04

MOS产品焊盘尺寸图

Mosfet weld pad size drawing

1 整流器件产品焊盘尺寸图

Rectifiers weld pad size drawing

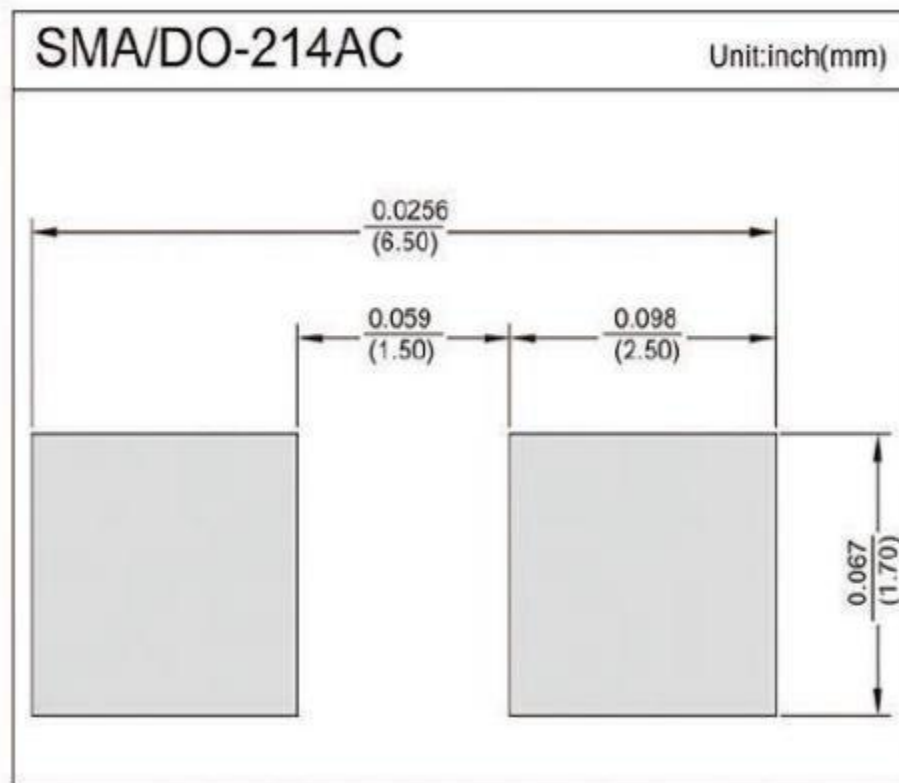
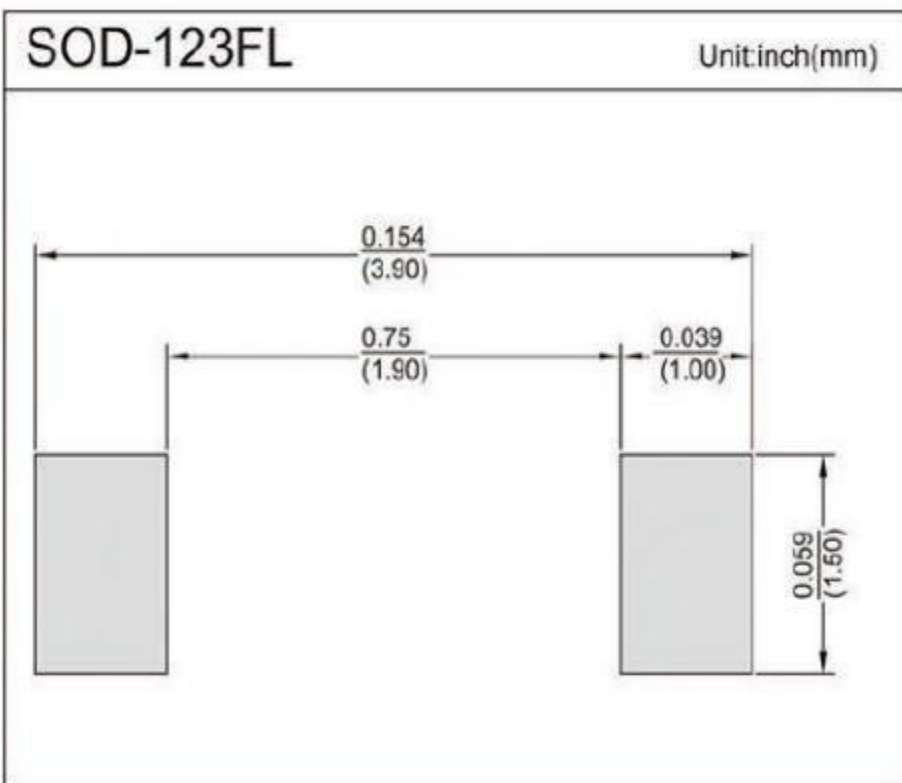

1

整流器件产品焊盘尺寸图

Rectifiers weld pad size drawing

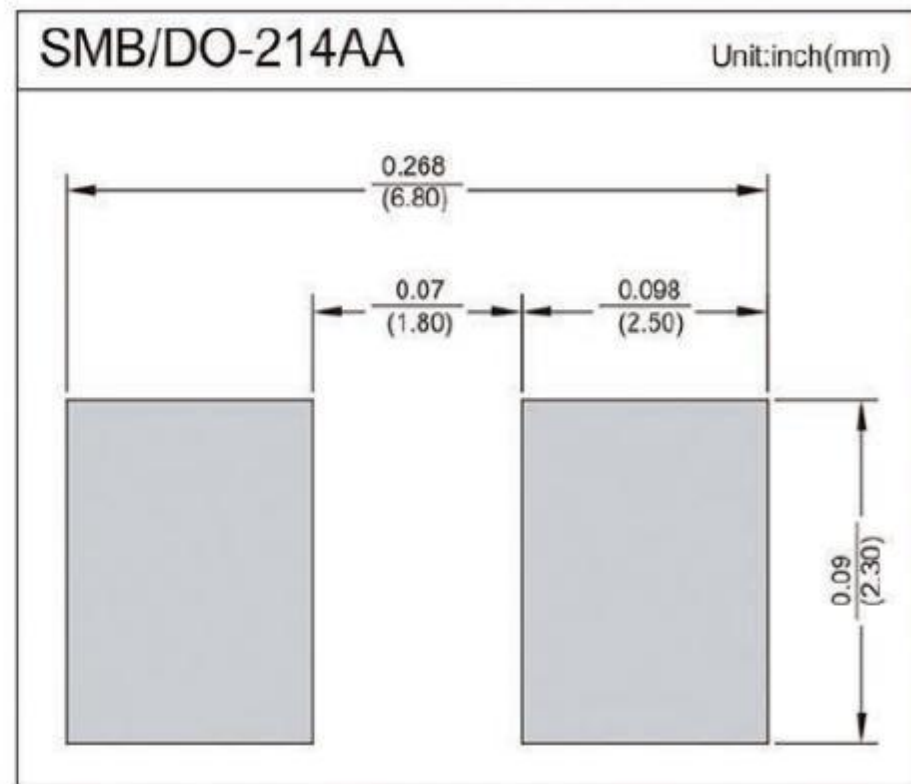
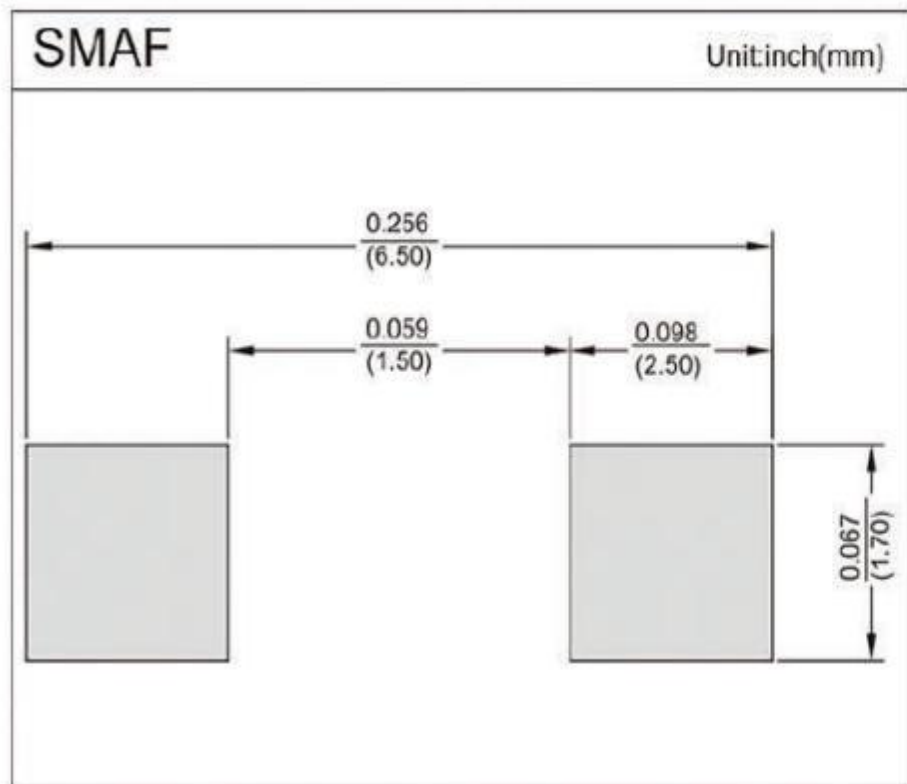

Rectifiers weld pad size drawing

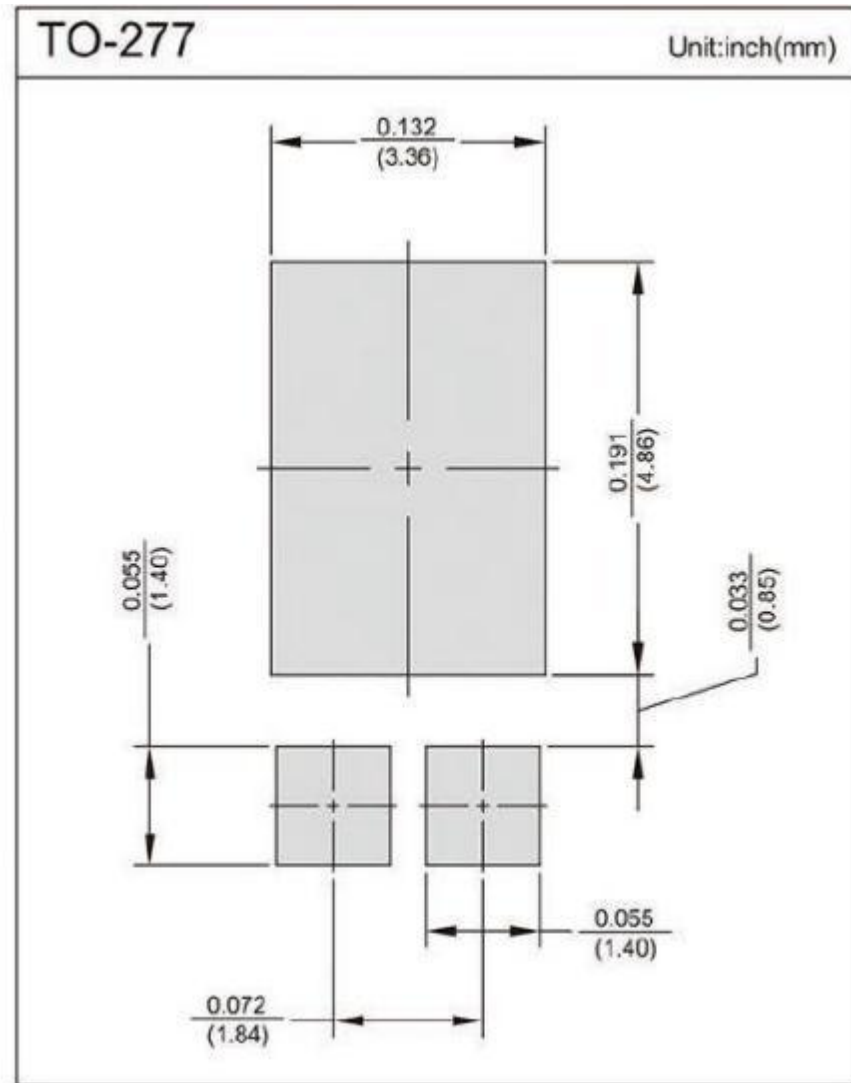
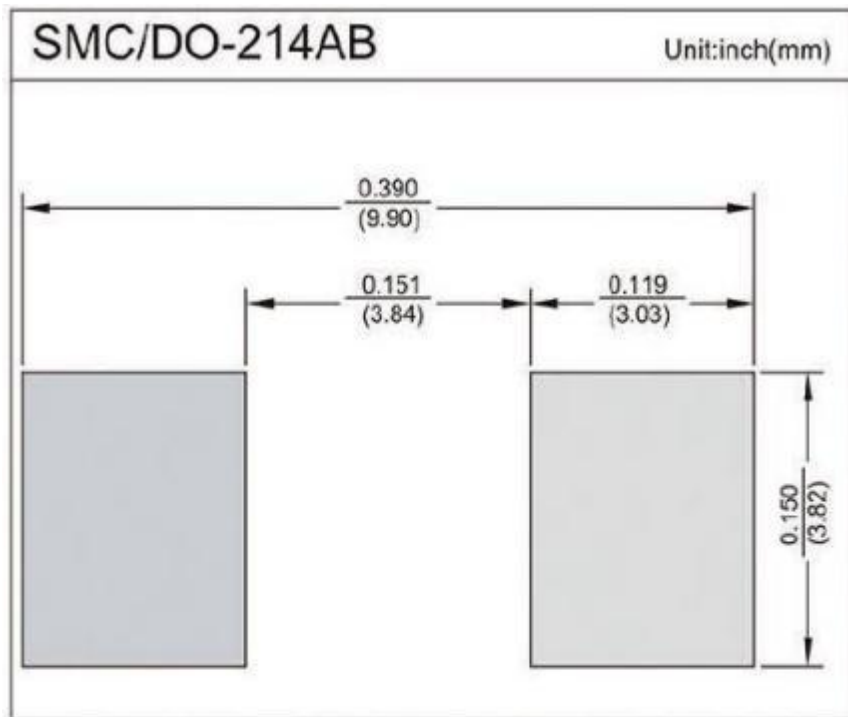

Rectifiers weld pad size drawing

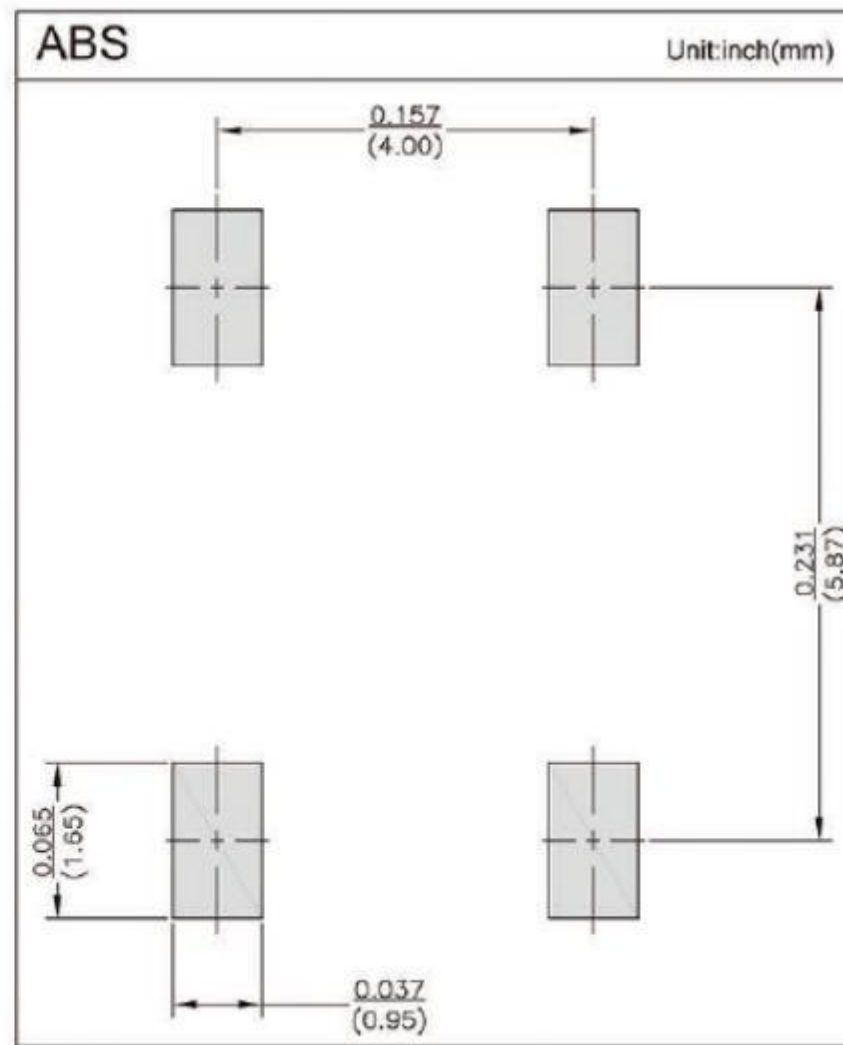
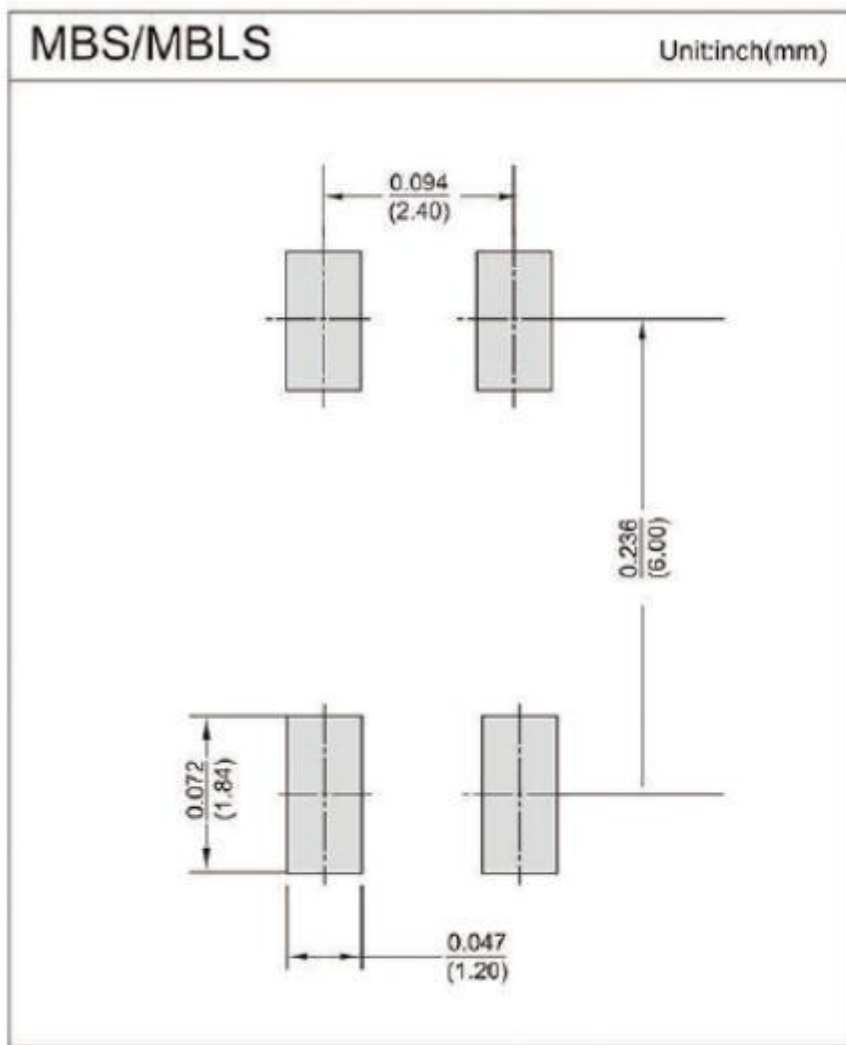

1

整流器件产品焊盘尺寸图

Rectifiers weld pad size drawing

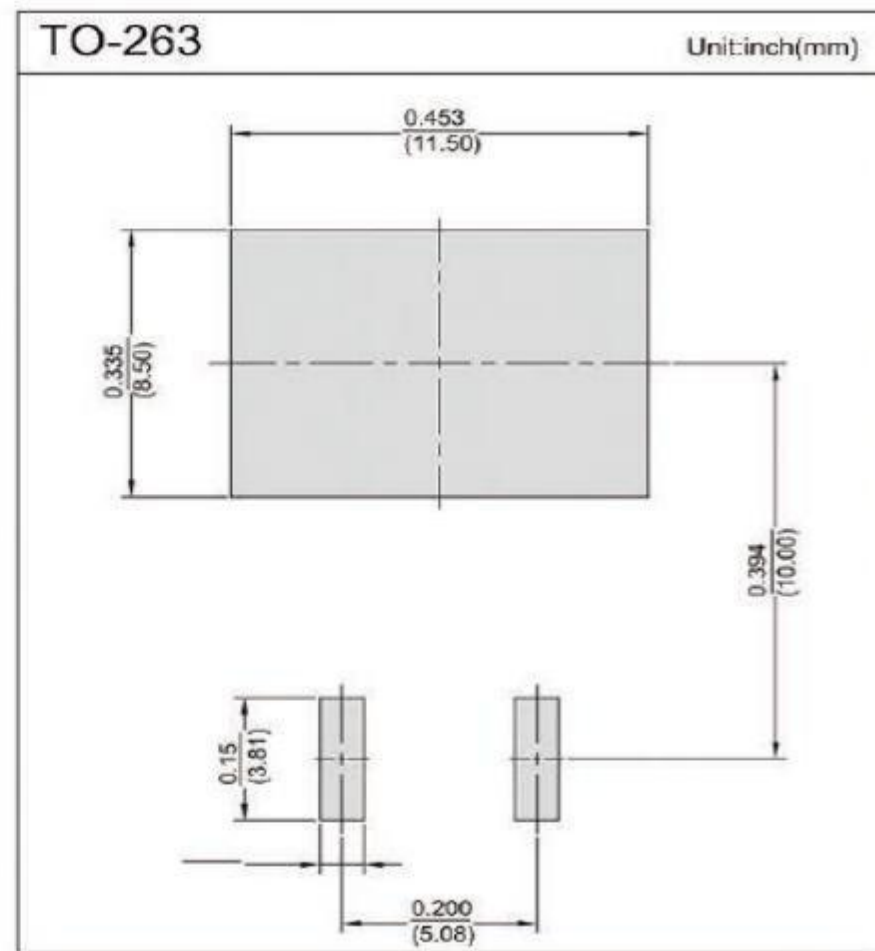
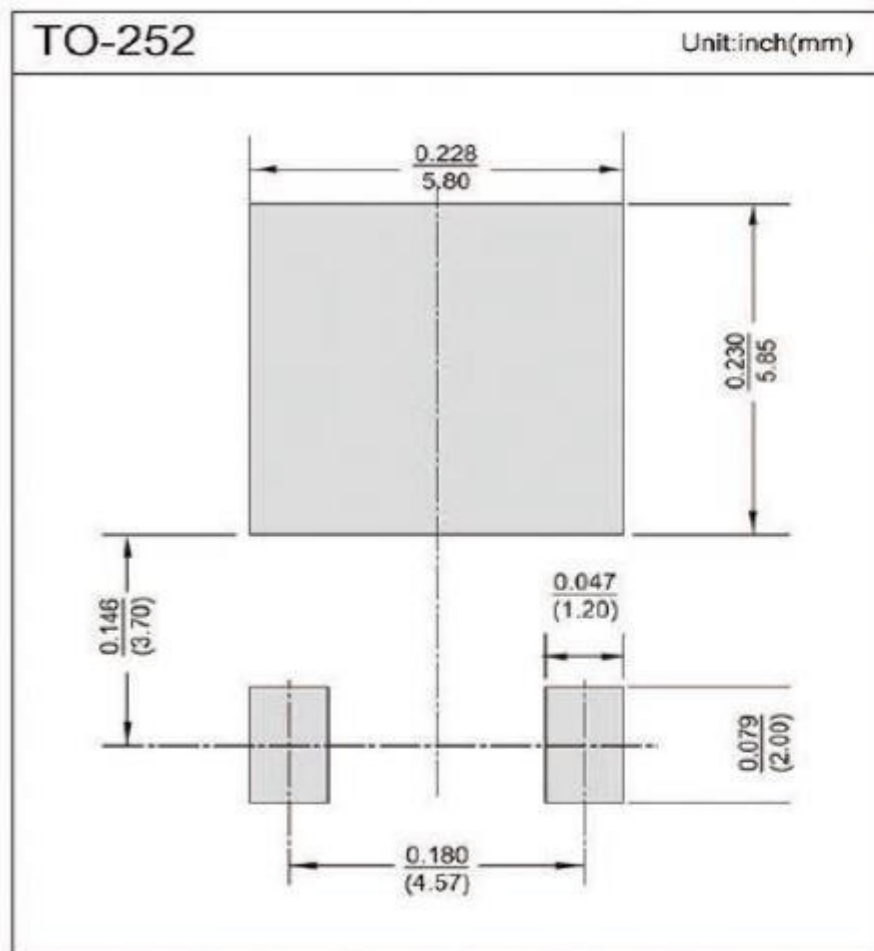

1 整流器件产品焊盘尺寸图

Rectifiers weld pad size drawing

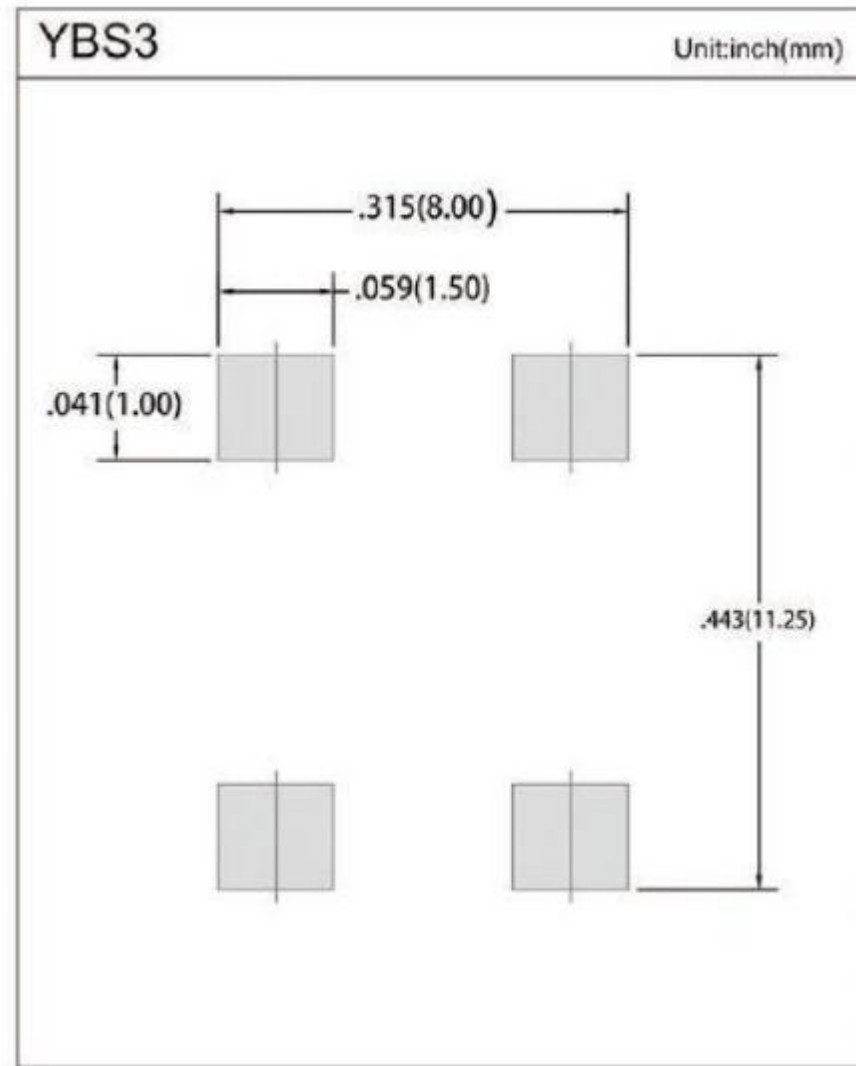
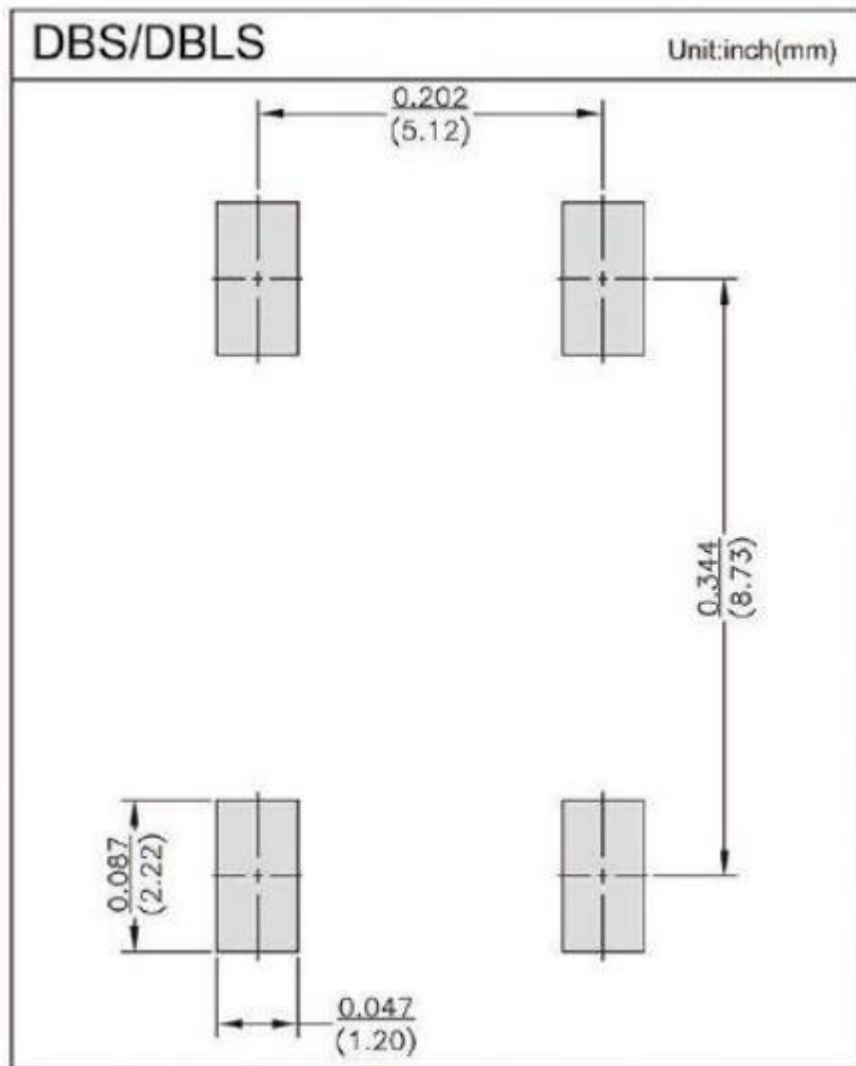

2 保护器件产品焊盘尺寸图

protection devices weld pad size drawing

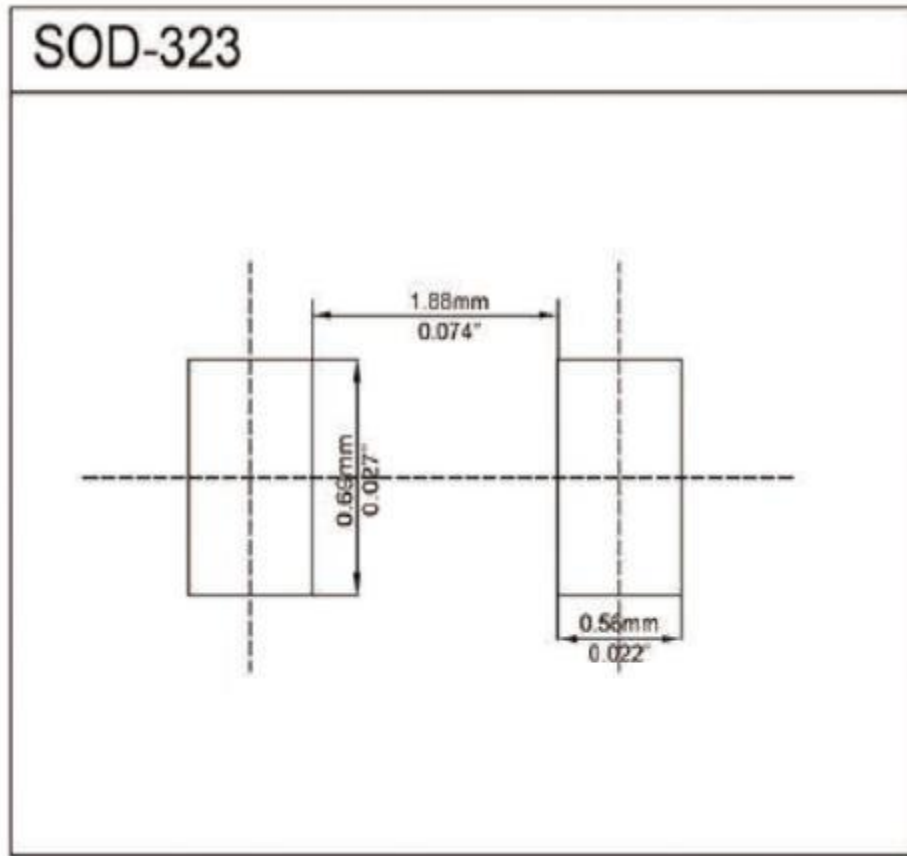
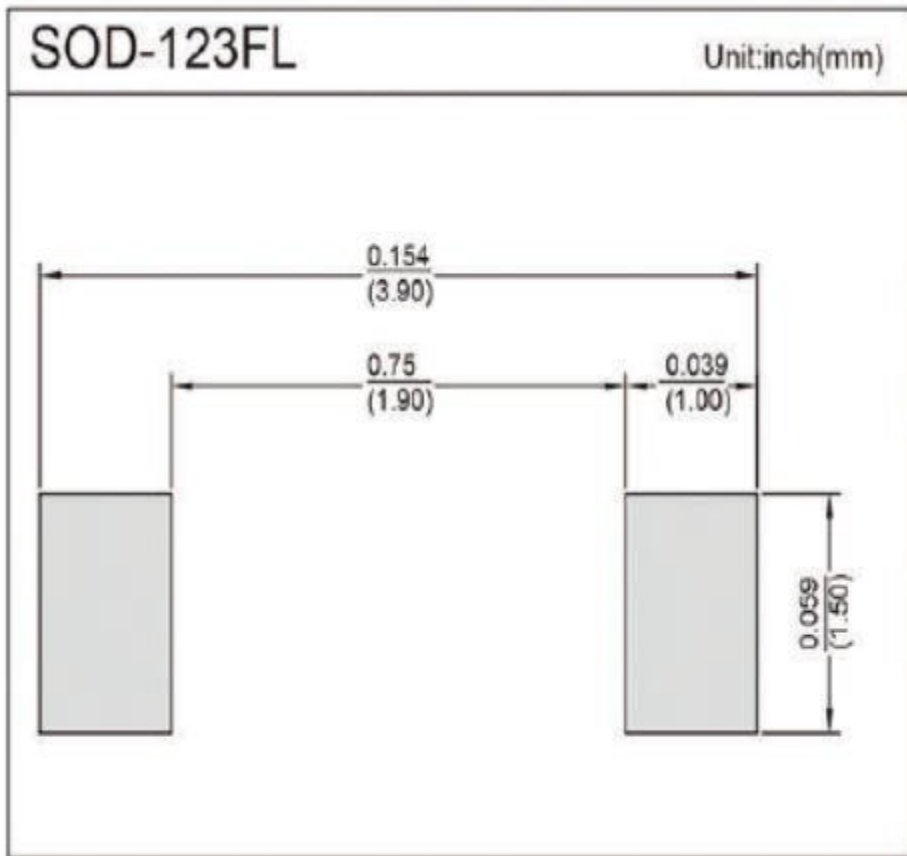

2 保护器件产品焊盘尺寸图

protection devices weld pad size drawing

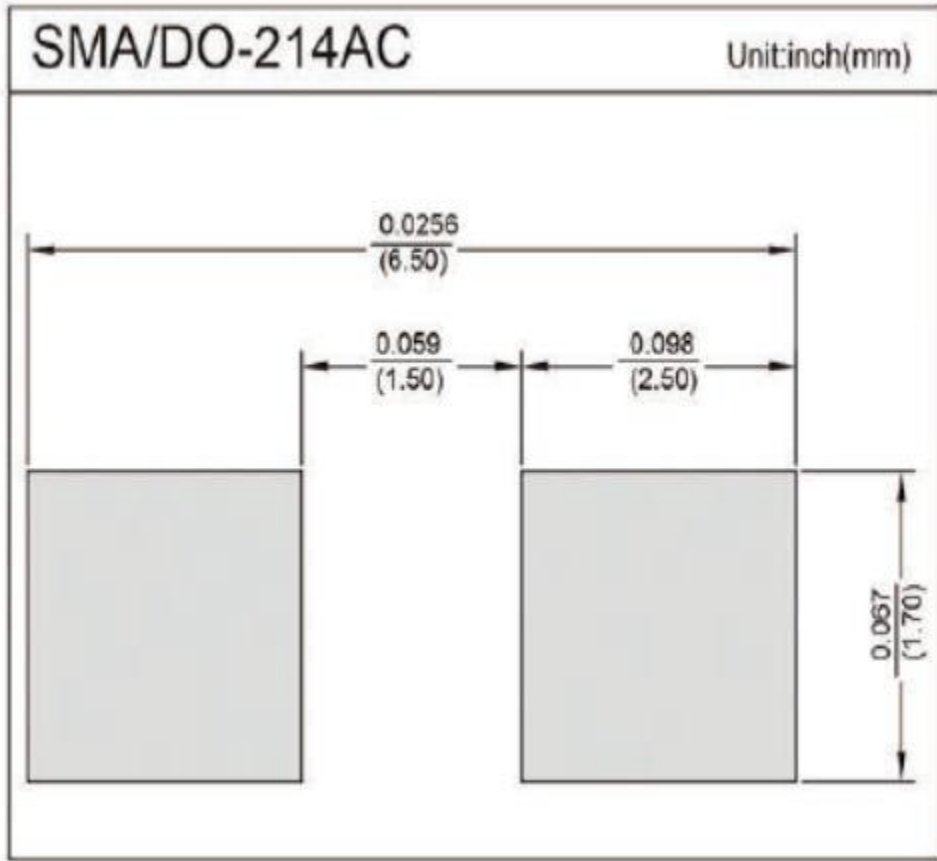
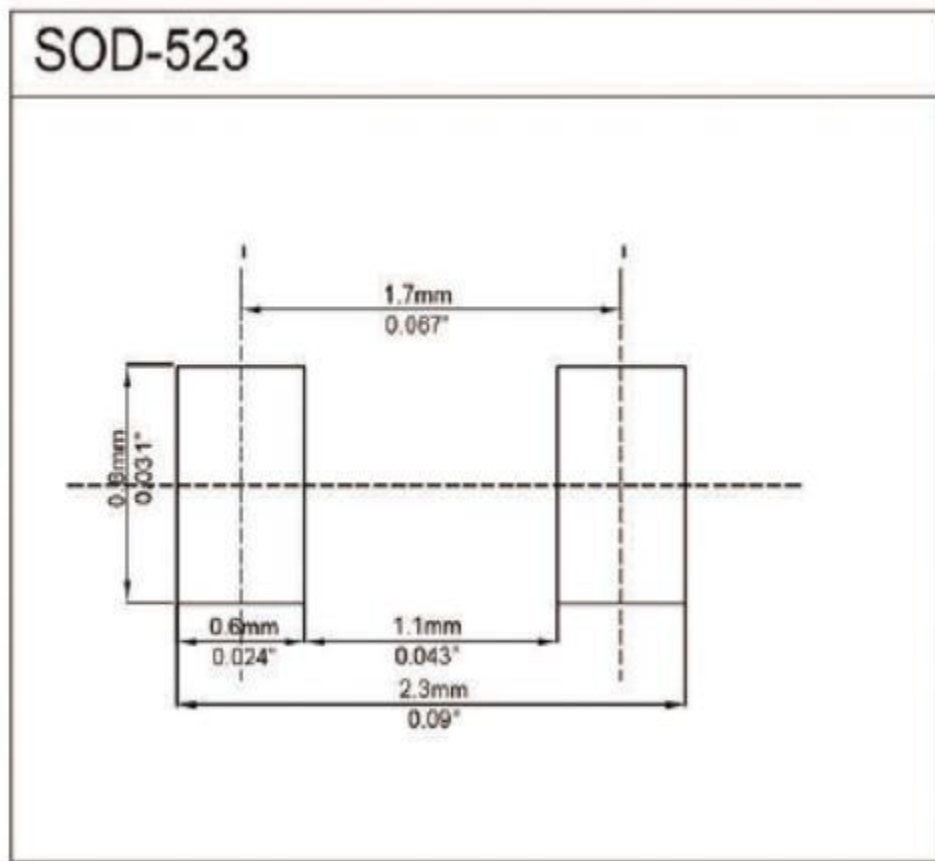

2 保护器件产品焊盘尺寸图

protection devices weld pad size drawing

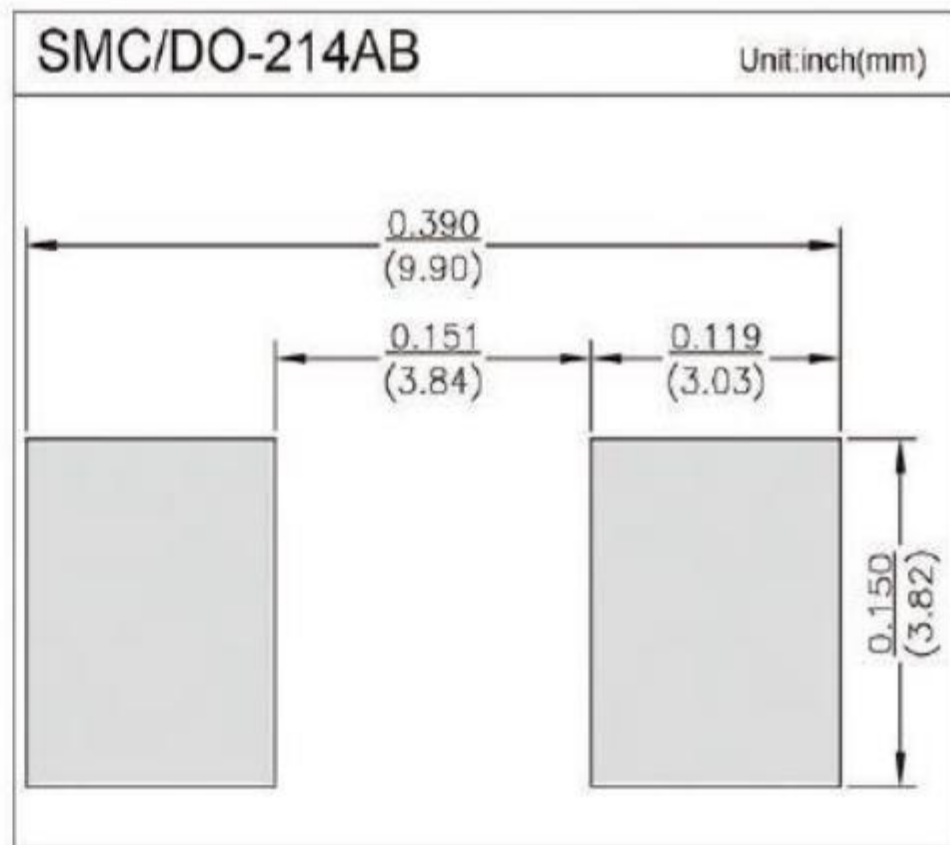
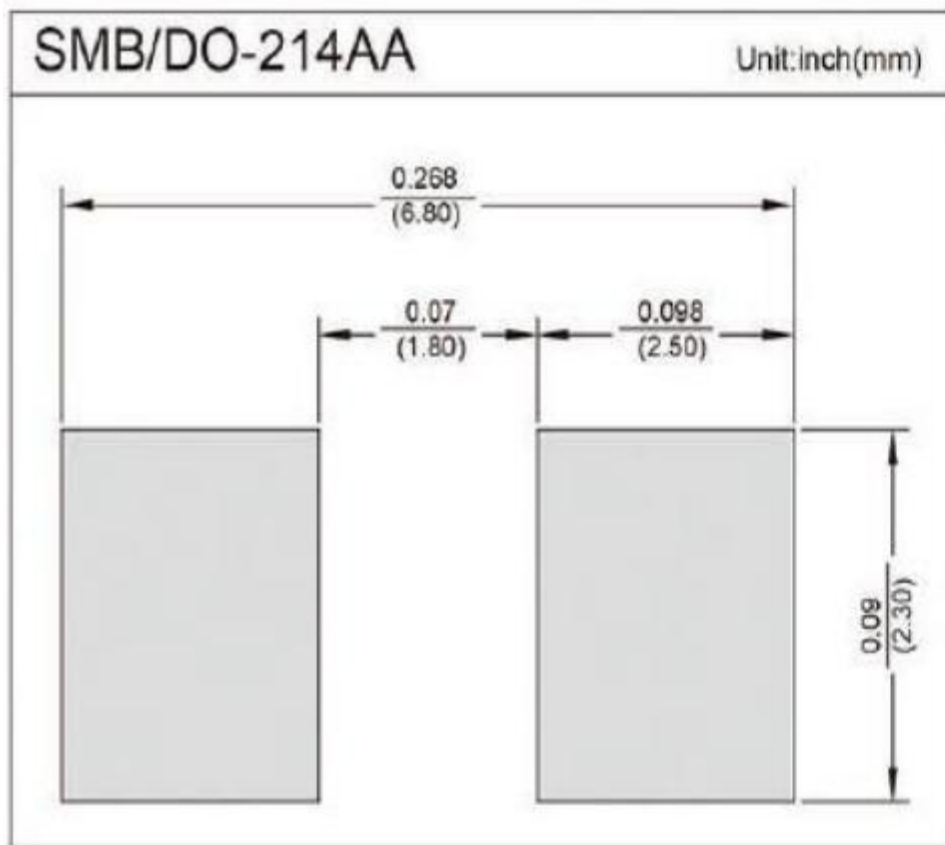

3 小信号产品焊盘尺寸图

small signal weld pad size drawing

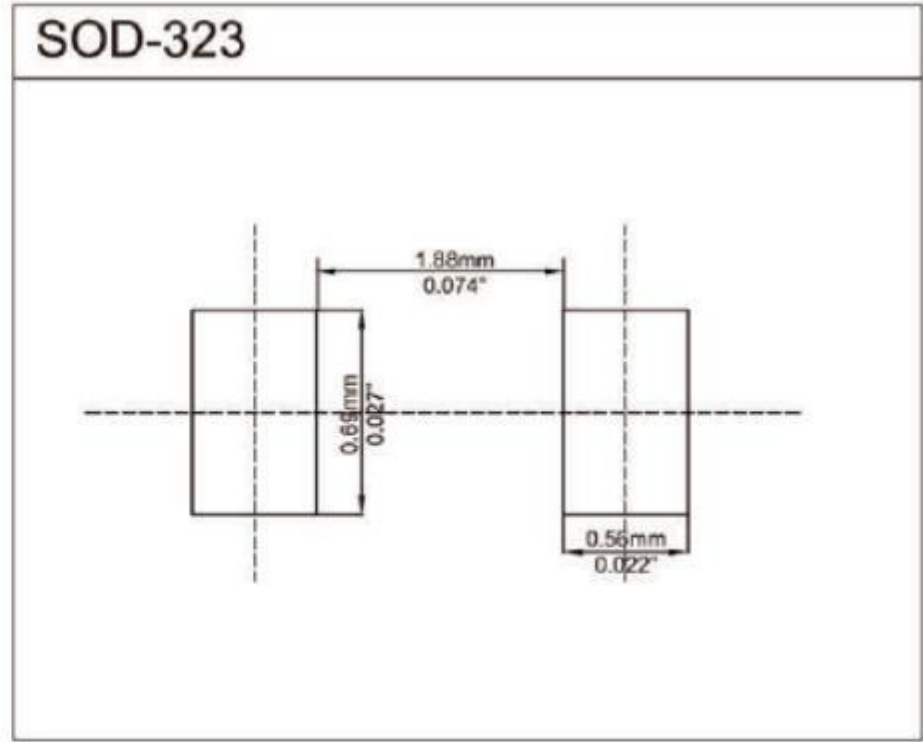
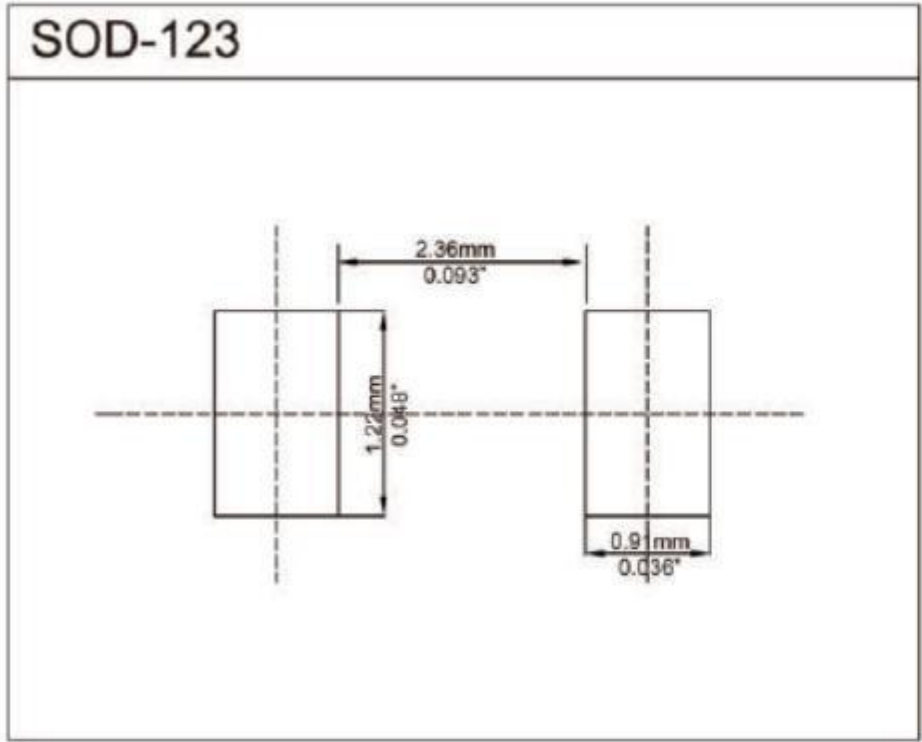

3 小信号产品焊盘尺寸图

small signal weld pad size drawing

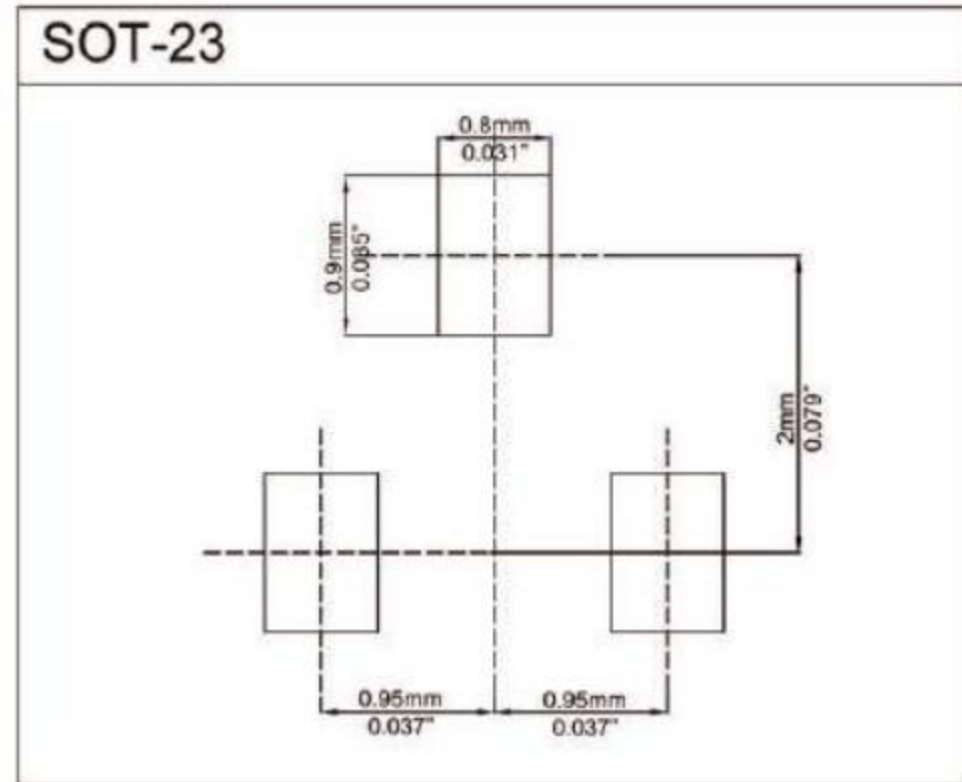
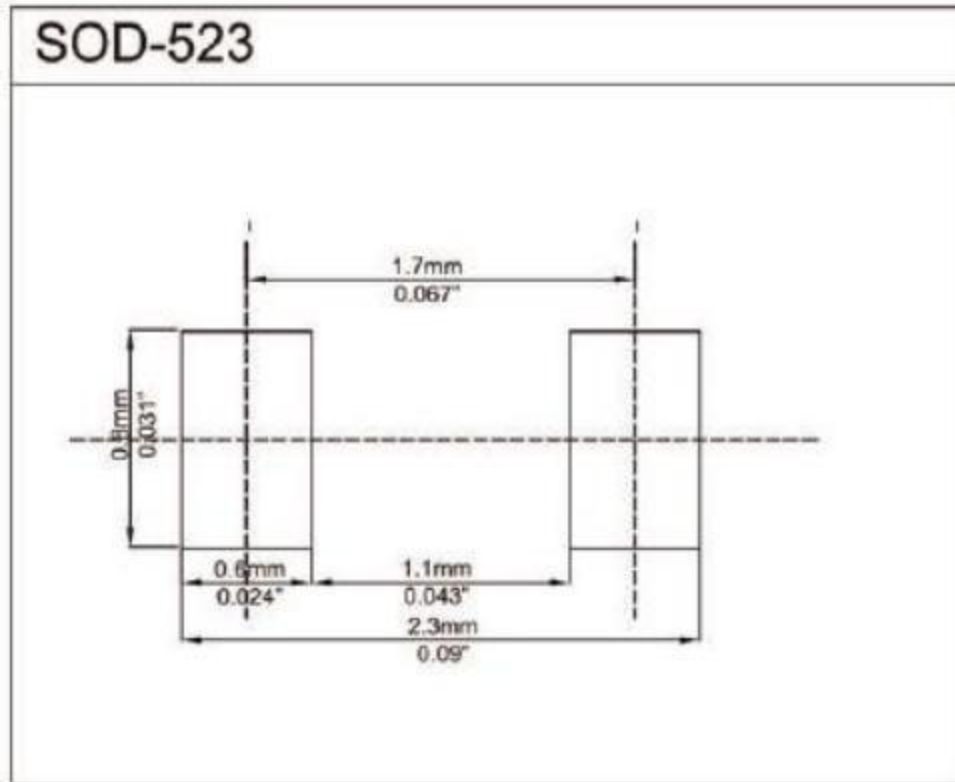

3 小信号产品焊盘尺寸图

small signal weld pad size drawing

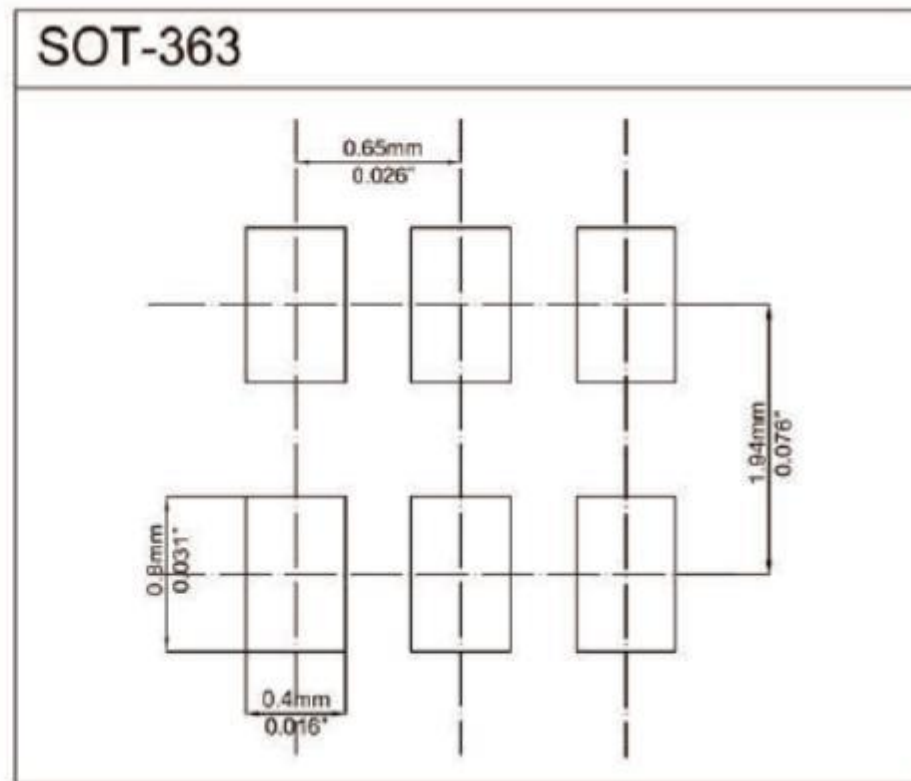
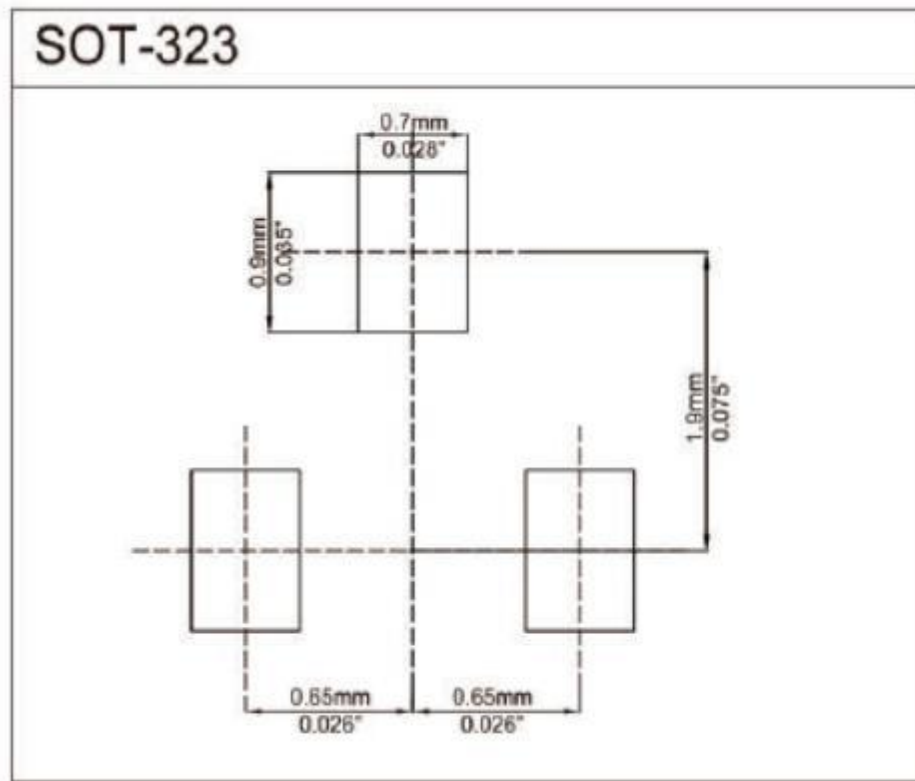

Mosfet weld pad size drawing

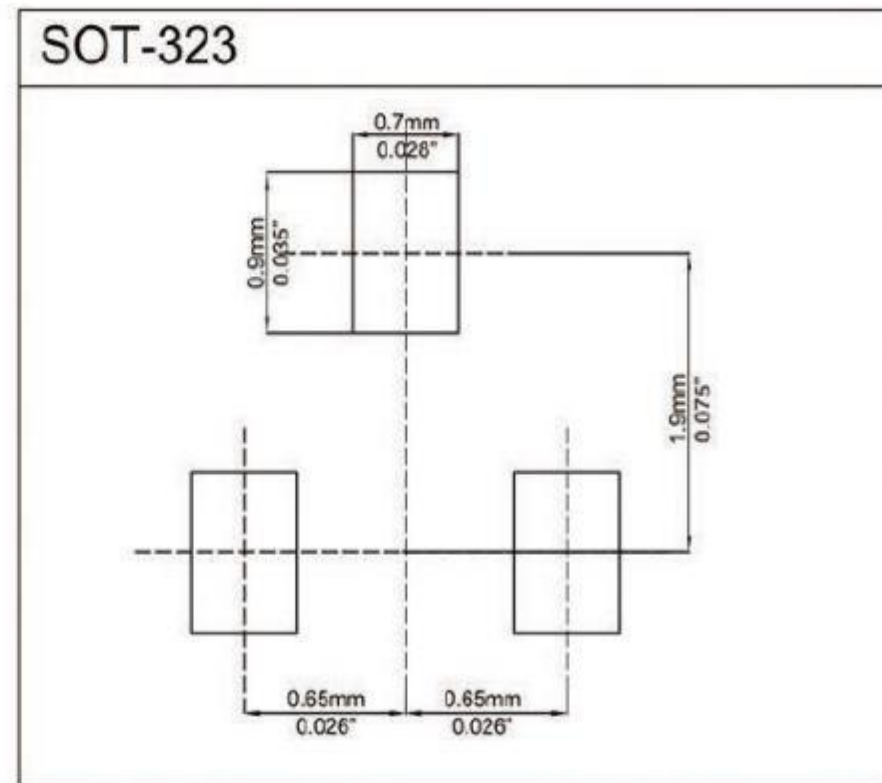
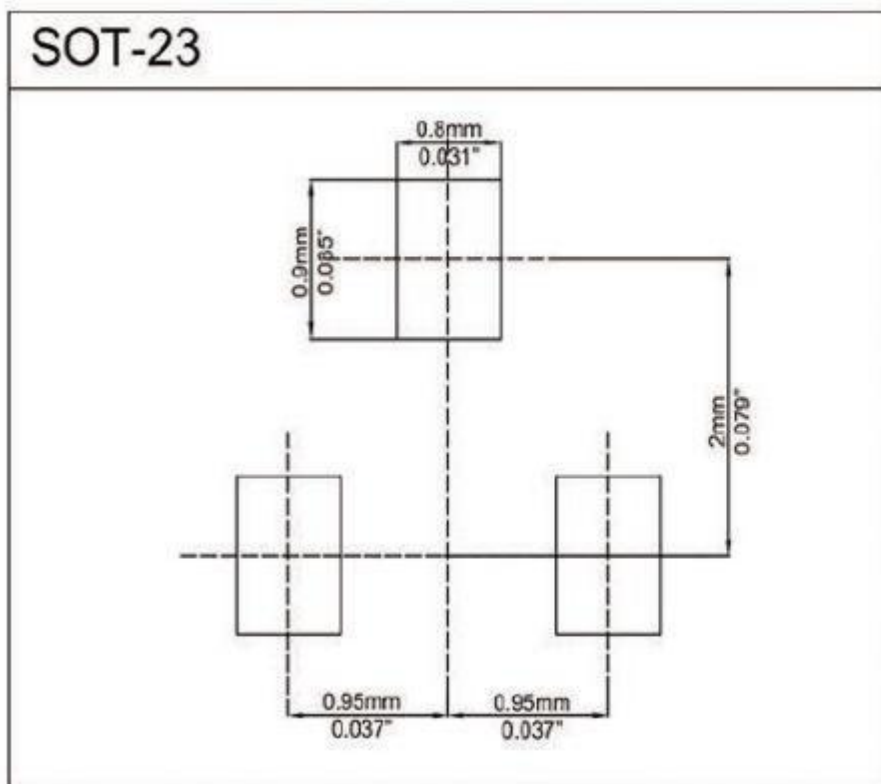

Mosfet weld pad size drawing

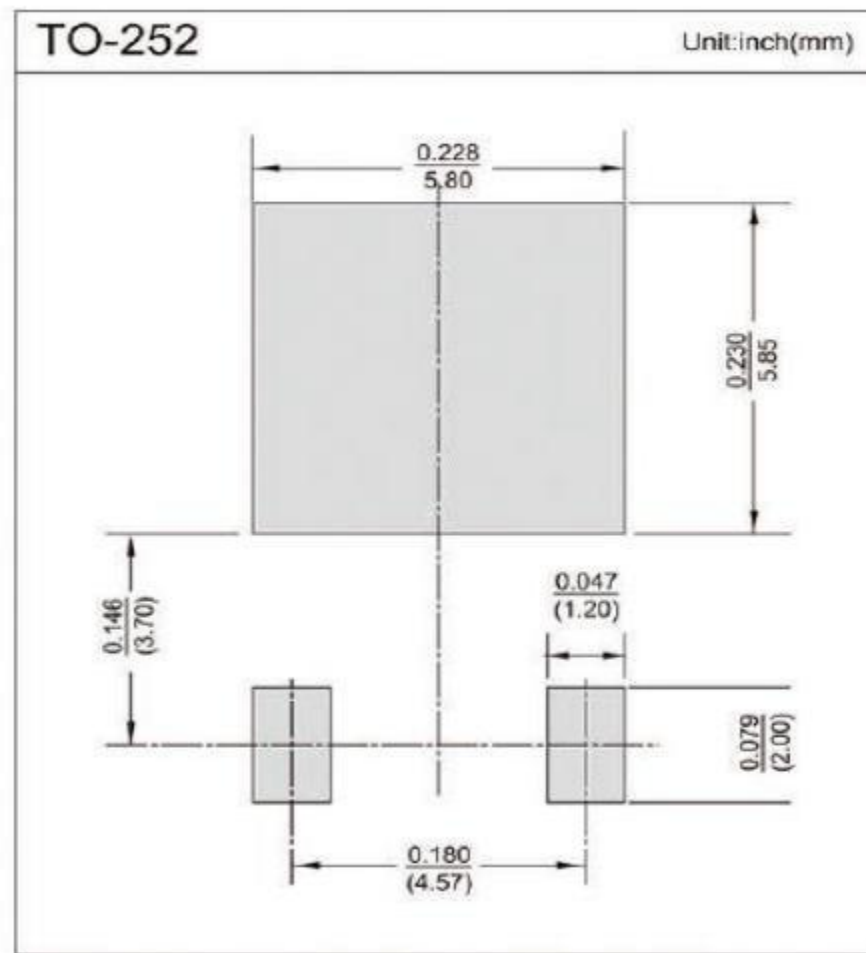
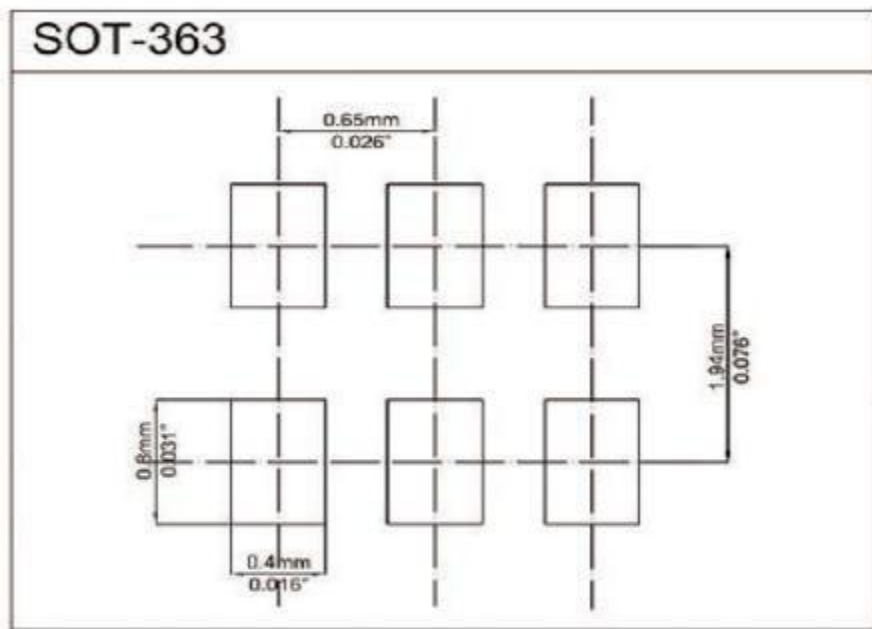



Thanks

感谢您的聆听