

N-Channel Enhancement Mode Field Effect Transistor

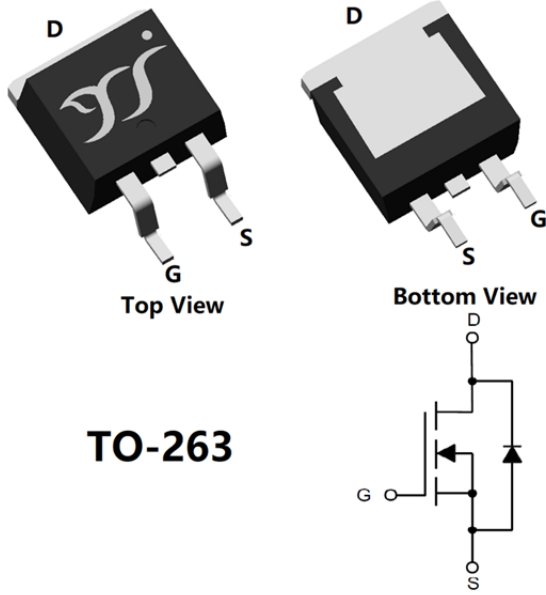

TO-263

Product Summary

- V_{DS} 40V
- I_D 155A
- $R_{DS(ON)}$ (at $V_{GS}=10V$) <2.5mohm
- 100% EAS Tested
- 100% ∇V_{DS} Tested

General Description

- Excellent package for heat dissipation
- High density cell design for low $R_{DS(ON)}$
- Moisture Sensitivity Level 1
- Epoxy Meets UL 94 V-0 Flammability Rating
- Halogen Free
- Part no. with suffix "Q" means AEC-Q101 qualified

Applications

- Power switching application
- Uninterruptible power supply
- DC-DC convertor
- 12V Automotive systems

■ Absolute Maximum Ratings ($T_A=25^\circ C$ unless otherwise noted)

Parameter		Symbol	Limit	Unit
Drain-source Voltage		V_{DS}	40	V
Gate-source Voltage		V_{GS}	± 20	V
Drain Current	$T_A=25^\circ C$	I_D	28	A
	$T_A=100^\circ C$		20	
	$T_C=25^\circ C$		155	
	$T_C=100^\circ C$		109	
Pulsed Drain Current ^A		I_{DM}	465	A
Avalanche energy ^B		EAS	937	mJ
Total Power Dissipation ^C	$T_A=25^\circ C$	P_D	5	W
	$T_A=100^\circ C$		2.5	
	$T_C=25^\circ C$		150	
	$T_C=100^\circ C$		75	
Junction and Storage Temperature Range		T_J, T_{STG}	-55~+175	$^\circ C$

■ Thermal resistance

Parameter		Symbol	Typ	Max	Units
Thermal Resistance Junction-to-Ambient ^D	Steady-State	$R_{\theta JA}$	25	30	$^\circ C/W$
Thermal Resistance Junction-to-Case	Steady-State	$R_{\theta JC}$	0.8	1	

■ Ordering Information (Example)

PREFERRED P/N	PACKING CODE	Marking	MINIMUM PACKAGE(pcs)	INNER BOX QUANTITY(pcs)	OUTER CARTON QUANTITY(pcs)	DELIVERY MODE
YJB155G04HHQ	F2	YJB155G04H	800	/	8000	13" reel



YJB155G04HHQ

■ Electrical Characteristics (T_J=25°C unless otherwise noted)

Parameter	Symbol	Conditions	Min	Typ	Max	Units
Static Parameter						
Drain-Source Breakdown Voltage	BV _{DSS}	V _{GS} =0V, I _D =250μA	40			V
Zero Gate Voltage Drain Current	I _{DSS}	V _{DS} =40V, V _{GS} =0V			1	μA
Gate-Body Leakage Current	I _{GSS}	V _{GS} =±20V, V _{DS} =0V			±100	nA
Gate Threshold Voltage	V _{GS(th)}	V _{DS} =V _{GS} , I _D =250μA	2	3	4	V
Static Drain-Source On-Resistance	R _{DS(on)}	V _{GS} =10V, I _D =20A		1.9	2.5	mΩ
Diode Forward Voltage	V _{SD}	I _S =20A, V _{GS} =0V		0.8	1.2	V
Gate resistance	R _G	f=1MHz		1.0		Ω
Dynamic Parameters						
Input Capacitance	C _{iss}	V _{DS} =25V, V _{GS} =0V, f=1MHz	-	4650	-	pF
Output Capacitance	C _{oss}		-	1280	-	
Reverse Transfer Capacitance	C _{rss}		-	25	-	
Switching Parameters						
Total Gate Charge	Q _g	V _{GS} =10V, V _{DS} =20V, I _D =55A	-	56.56	-	nC
Gate-Source Charge	Q _{gs}		-	27	-	
Gate-Drain Charge	Q _{gd}		-	5.66	-	
Reverse Recovery Charge	Q _{rr}	I _F =55A, di/dt=100A/us	-	52.58	-	nC
Reverse Recovery Time	t _{rr}		-	58.2	-	ns
Turn-on Delay Time	t _{D(on)}	V _{GS} =10V, V _{DD} =20V, I _D =55A R _{GEN} =3Ω	-	21.8	-	ns
Turn-on Rise Time	t _r		-	8.6	-	
Turn-off Delay Time	t _{D(off)}		-	43.8	-	
Turn-off fall Time	t _f		-	51.7	-	

A. Repetitive rating; pulse width limited by max. junction temperature.

B. T_J=25°C, V_{DD}=45V, V_G=10V, R_G=25Ω, L=3mH, I_{AS}=25A.

C. P_d is based on max. junction temperature, using junction-case thermal resistance.

D. The value of R_{θJA} is measured with the device mounted on 1in2 FR-4 board with 2oz. Copper, in a still air environment with T_A=25°C. The maximum allowed junction temperature of 175°C. The value in any given application depends on the user's specific board design.



YJB155G04HHQ

Typical Electrical and Thermal Characteristics Diagrams

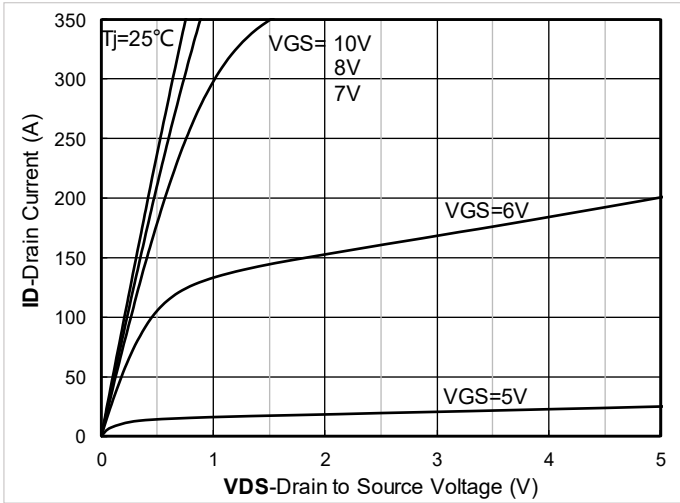

Figure1. Output Characteristics

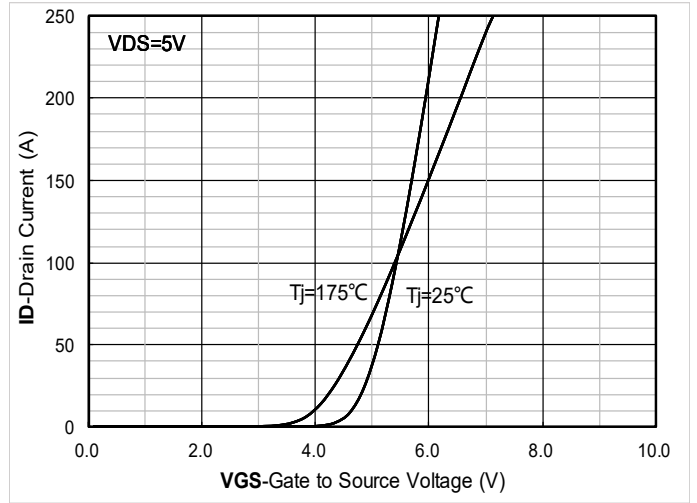

Figure2. Transfer Characteristics

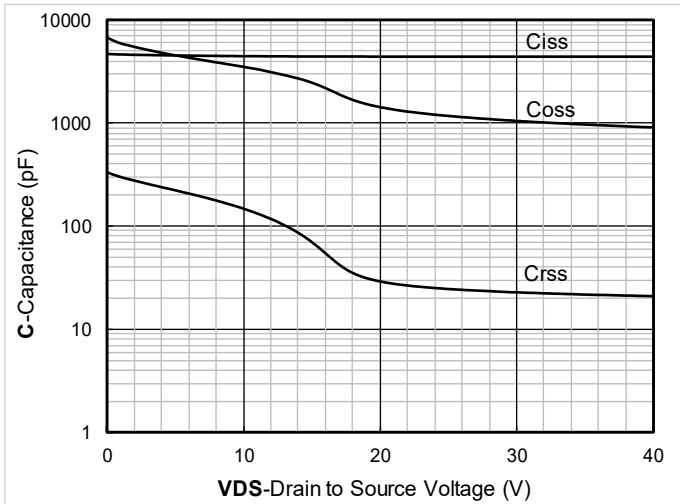

Figure3. Capacitance Characteristics

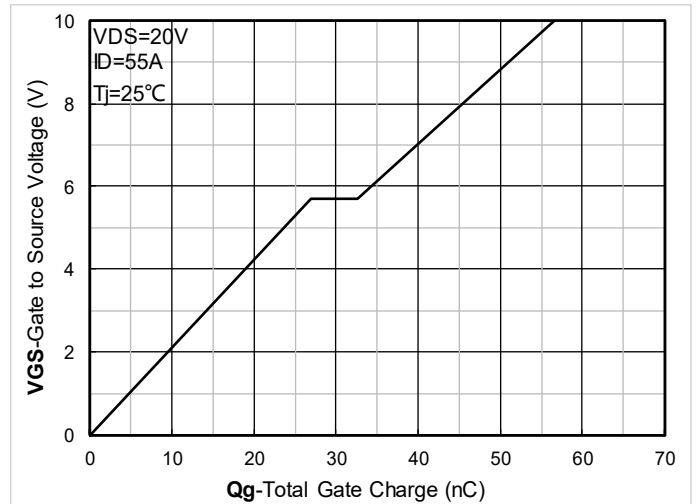

Figure4. Gate Charge

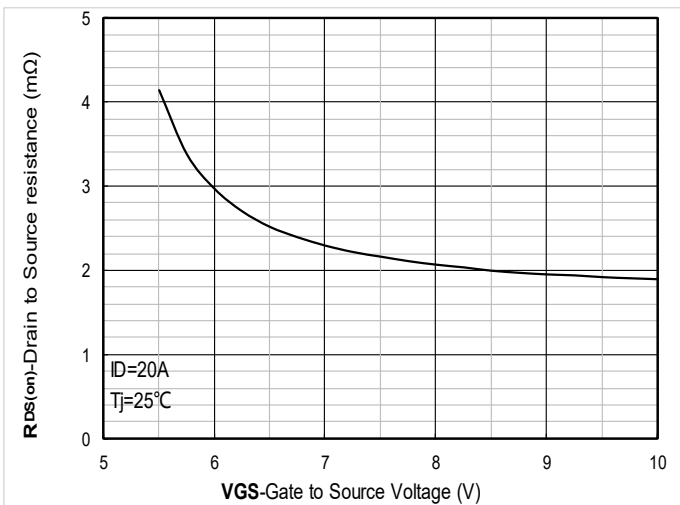

Figure5. On-Resistance vs Gate to Source Voltage

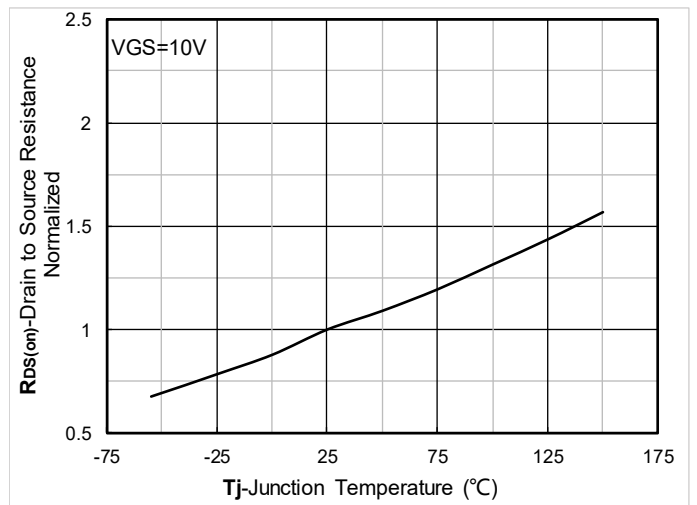

Figure6. Normalized On-Resistance



YJB155G04HHQ

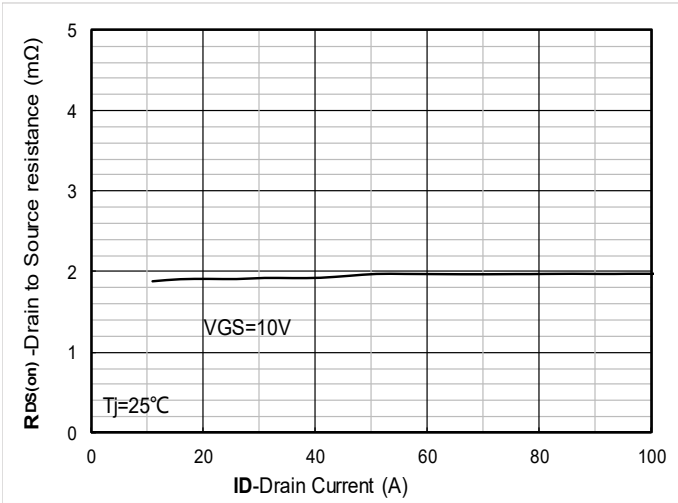

Figure7. RDS(on) VS Drain Current

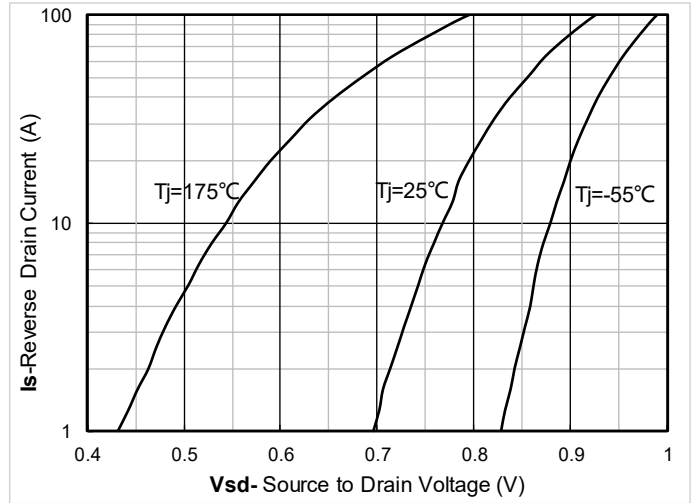

Figure8. Forward characteristics of reverse diode

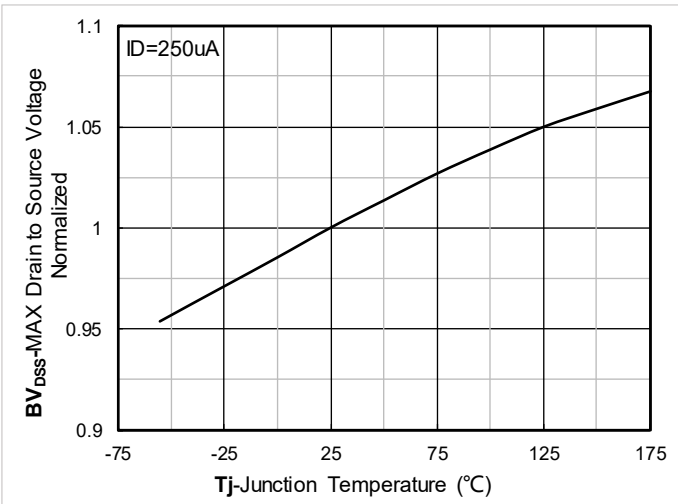

Figure9. Normalized breakdown voltage

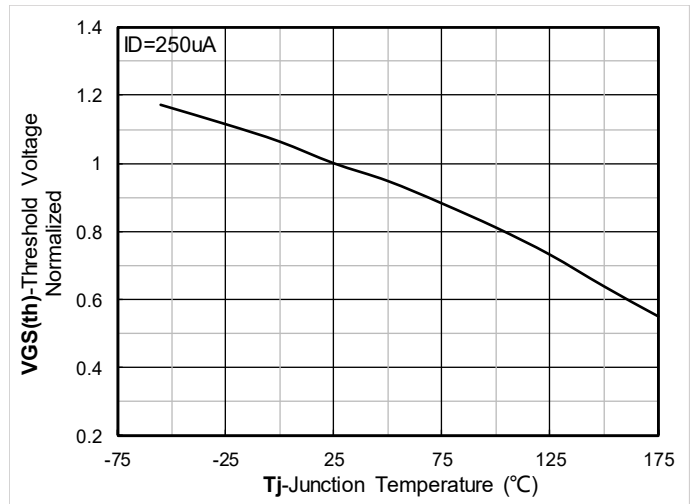

Figure10. Normalized Threshold voltage

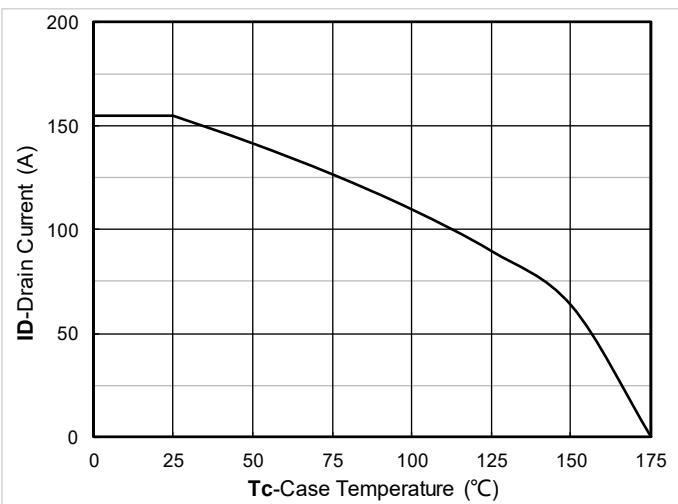

Figure11. Current dissipation

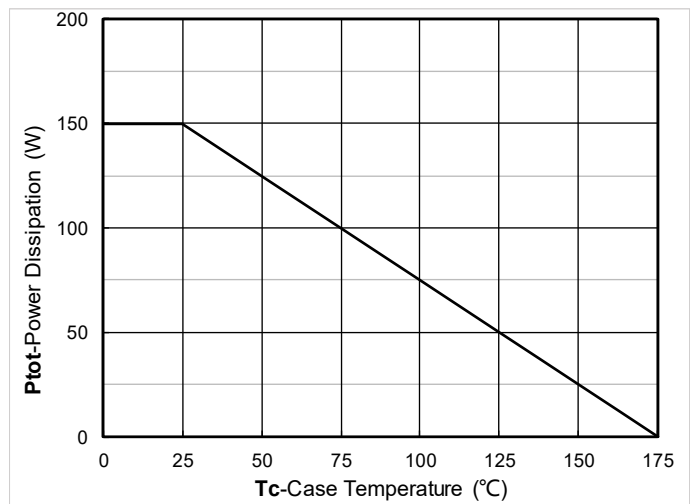

Figure12. Power dissipation



YJB155G04HHQ

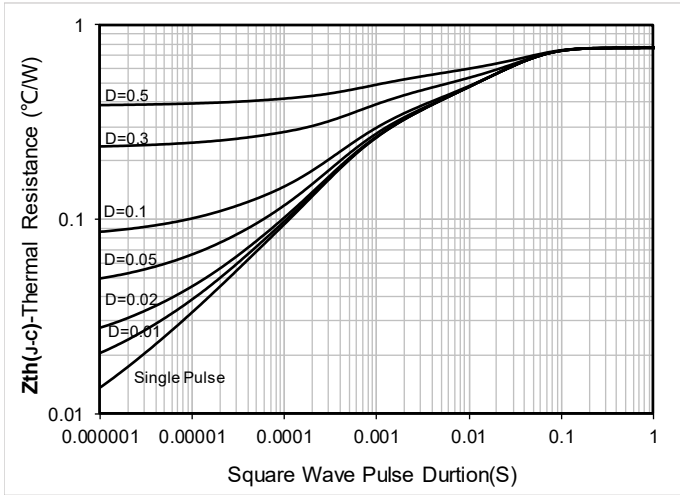

Figure13. Maximum Transient Thermal Impedance

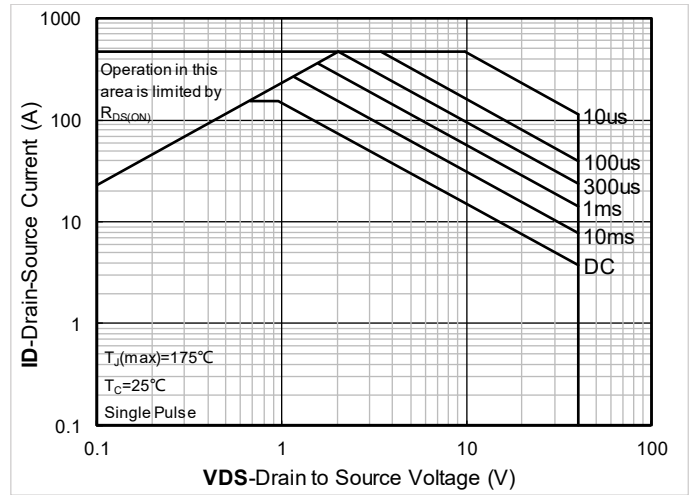
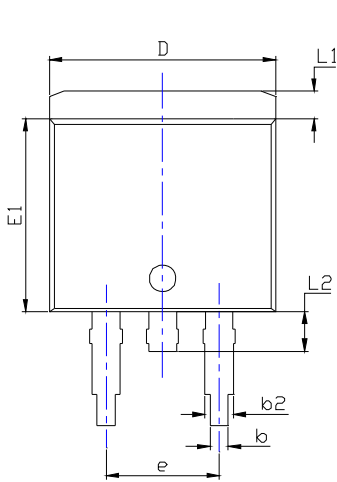

Figure14. Safe Operation Area



YJB155G04HHQ

■ TO-263-HY Package information



TOP VIEW

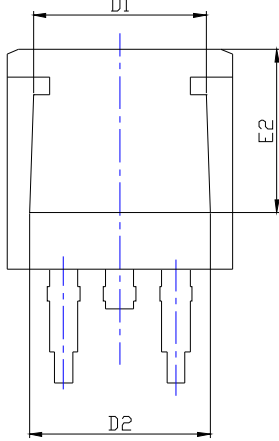

BOTTOM VIEW

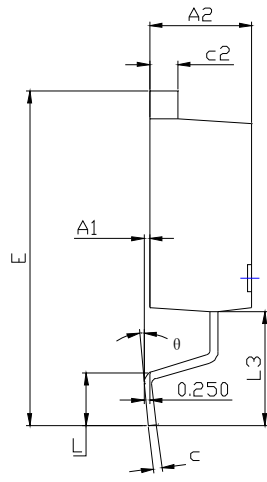

SIDE VIEW

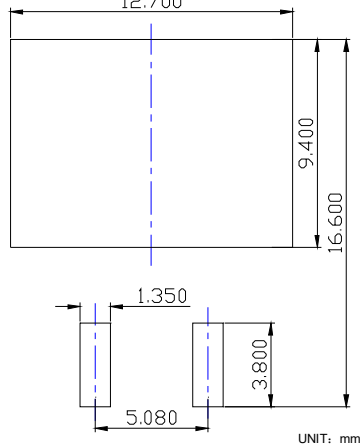

SUGGESTED SOLDER PAD LAYOUT

UNIT: mm

SYMBOL	DIMENSIONS					
	INCHES			Millimeter		
	MIN.	NDM.	MAX.	MIN.	NDM.	MAX.
A1	0.000	---	0.010	0.000	---	0.250
A2	0.174	0.180	0.186	4.430	4.580	4.730
b	0.028	0.032	0.036	0.720	0.820	0.920
b2	0.046	0.050	0.054	1.180	1.280	1.380
c	0.013	0.015	0.018	0.330	0.390	0.450
c2	0.048	0.050	0.053	1.220	1.280	1.340
D	0.394	0.400	0.406	10.000	10.150	10.300
D1	0.295	0.307	0.319	7.500	7.800	8.100
D2	0.303	0.315	0.327	7.700	8.000	8.300
E	0.571	0.591	0.610	14.500	15.000	15.500
E1	0.337	0.341	0.348	8.550	8.700	8.850
E2	0.276	0.287	0.299	7.000	7.300	7.600
e	0.200BSC			5.080BSC		
L	0.070	---	0.110	1.790	---	2.790
L1	0.044	---	0.056	1.120	---	1.420
L2	0.030	---	0.070	0.770	---	1.770
L3	0.197REF			5.000REF		
θ	0°	---	8°	0°	---	8°

NOTE:

- 1.PACKAGE BODY SIZES EXCLUDE MOLD FLASH AND GATE BURRS.
- 2.TOLERANCE 0.1mm UNLESS OTHERWISE SPECIFIED.
- 3.THE PAD LAYOUT IS FOR REFERENCE PURPOSES ONLY.



YJB155G04HHQ

Disclaimer

The information presented in this document is for reference only. Yangzhou Yangjie Electronic Technology Co., Ltd. reserves the right to make changes without notice for the specification of the products displayed herein to improve reliability, function or design or otherwise.

The product listed herein is designed to be used with automotive electronics, are not designed for use in medical, life-saving, lifesustaining, or military, Yangjie or anyone on its behalf, assumes no responsibility or liability for any damages resulting from such improper use of sale.

This publication supersedes & replaces all information previously supplied. For additional information, please visit our website <http://www.21yangjie.com>, or consult your nearest Yangjie's sales office for further assistance.